



FL250 FLOORLINE BED

USER MANUAL



Thank you for choosing this Aidacare FL250 Bed.

This bed has been specifically designed to offer comfort, support and safety.

It is important that you read this user manual carefully before using your new bed.



This product features the CE mark, in compliance with the Medical Devices Regulation 2002 (as amended) Class 1, and the Medical Device Regulation 2017/745.



This product Features the UKCA mark, in compliance with Part II UK MDR 2002 (as amended) Class 1



IMPORTANT: Do not use the Aidacare FL250 Bed without having first read this user manual

© Aidacare Limited 2024

No part of this user manual may be copied, distributed, reproduced, scanned or stored on any electronic database, whether in whole or in part in any form or by any means.

Due care has been taken to ensure all the information contained in this user manual is correct at the time of printing. All measurements, pictures, colours and weight capacities are to be used as a guide only. We reserve the right to modify the design or appearance of any product displayed in this user manual without prior notice.

TABLE OF CONTENTS

1. Symbols Used in This Manual	4
2. Symbols Used on the Product	5
3. Introduction	6
4. Safety Precautions	7
5. Overview	9
6. Specifications	10
7. Accessories	11
8. Electronic Functions	13
9. Assembly	16
10. General Operation	53
11. Storage & Movement	55
12. Cleaning	57
13. Maintenance	58
14. Troubleshooting	59
15. Warranty & Service	60
16. Service Log Book	61
17. Notes	62

1. SYMBOLS USED IN THIS MANUAL

The symbols below are used throughout this owner's manual and on the product to identify warnings and important information. It is very important for you to read them and understand them completely.



Indicates a potentially hazardous condition/situation. Failure to follow designated procedures can cause either personal injury, component damage or malfunction. On the product, this icon is represented as a black symbol on a white triangle with a black border.



ALWAYS! These actions should be performed as specified. Failure to perform mandatory actions can cause personal injury and/or equipment damage. On the product, this icon is represented as a white infinity symbol on a black dot with a white border.



DO NOT! These actions are prohibited. These actions should not be performed at any time or in any circumstances. Performing a prohibited action can cause personal injury and/or equipment damage. On the product, this icon is represented as a white symbol with a black circle and black slash.

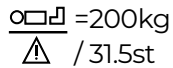

MAXIMUM PATIENT WEIGHT. This weight represents the total maximum weight of a patient on the bed. This weight (200kg / 31.5st) should not be exceeded at any time.

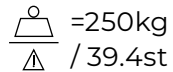

SAFE WORKING LOAD (SWL). This weight represents the total maximum weight that the bed can carry, including patient, mattress, bedding, bed ends and accessories. This weight (250kg / 39.4st) should not be exceeded at any time.



Please scan the QR code or visit our website aidacare.com.au and search 'Aidacare FL250 (BEB046100 or BEB046150)' to access product marketing and technical documentation.

2. SYMBOLS USED ON THE PRODUCT



Sticker shown is not to scale.

	Product Code		CE Mark
	Serial Number		Read User Manual
	Manufacturer		Caution
	Importer		Medical Device
	Authorised Representative in EU		Maximum Patient Weight
	Country of Manufacture		Safe Working Load
	UKCA Mark		Type B as per IEC60601-1
	Includes Electronics components and should be mixed with General household waste		Class 2 Electrical Equipment



3. INTRODUCTION



The Aidacare FL250 Bed is an electrically operated Floorline Bed offering functions and positional movements that assist caregivers and maximise patient comfort and safety. Ease of use, functionality, serviceability and cleaning practicality are key features of the bed. The bed has a robotically welded steel structure with a leading anti corrosion treatment layer underlying the durable powder coated finish. The plastic components are made from urethane, PP and POM nylon and ABS plastic.

CLINICAL APPLICATIONS AND AREA OF USE

This bed is appropriate for adult patient care and should only be used under the instruction of a carer or health professional where concerns exist around patient safe use.

KEY FEATURES

 =250kg Maximum safe working load (SWL) of the bed is 250kg / 39.4st
 / 39.4st
with a suggested maximum user weight of 200kg / 31.5st which conservatively takes into account common accessories used with care beds such as alternating pressure mattresses, assist bars and foam mattresses.

 =200kg
 / 31.5st

- ExitSafe single button ingress / exit height
- BrakeFirst automatic safety brake activation at lowest height
- SmartDescent automatically slows lowering speed from 300mm / 12" above floor level to lowest position
Designed to improve resident and carer safety whilst reducing potential for damage to equipment such as air mattress pumps becoming trapped under the bed
- EasyMove Transport System – transport the FL250 bed with zero lifting for a truly safe manual handling process
- Electrically adjusted height range from 110mm / 4.3" to 740mm / 29.1"
- 75mm / 3" twin castors with single activation locking mechanism for ease of use
- Four section electrically operated mattress platform with independent adjustment of backrest angle (maximum 60°) and knee section angle (maximum 35°)
- Bi-lateral mattress retainers with length adjustable mattress extension retainer at foot end
- Integrated foot end extension. Extends the bed by 100mm / 4" or 210mm / 7.9"
- Large range of feature enhancing accessories
- Removable bed ends
- Automatically adjusting wall protection system
- Auto-regression integrated into backrest and leg section reduces sacral pressure, shear forces and abdominal compression during bed profiling

4. SAFETY PRECAUTIONS

This User Manual outlines the intended use of the Aidacare FL250 Bed, the intended use constitutes how to achieve full functionality whilst maximizing safety and efficiency for care staff and patients alike.

It is **important** that this User Manual is read in its entirety prior to operating the bed. The manual is designed to ensure that users are equipped with the information required to competently and responsibly operate the bed and its accessories.

It is recommended that the User Manual be kept in an easily accessible place for quick reference. If required Aidacare product specialists can provide additional training.

All warnings and cautions within this manual should be strictly adhered to. Failure to do so could result in harm to the patient or operator.



WARNINGS highlighted throughout this document identify possible hazards in procedures or conditions which if not followed correctly could result in serious injury, or fatality.



CAUTIONS highlighted throughout this manual identify possible hazards in procedures or conditions, which if not followed correctly could result in equipment damage, or failure.

GENERAL

- Electrical equipment can be hazardous if used incorrectly
- Residual current devices (RCD) are not supplied with FL250 Beds. Please consult with your Biomedical Engineer/advisor concerning RCD requirements
- The clinically qualified person responsible should consider the age, size and condition of the patient before using the bed and its accessories
- The maximum safe working load of the FL250 Bed is 250kg / 39.4st and includes the mass of the patient, mattress and any accessories fitted to the bed
- The maximum suggested standard mattress thickness for use with the FL250 Bed is 170mm / 6.7"
- The bed should only be used with approved accessories. Contact **Aidacare** for a full list of approved accessories
- If a patient's condition could lead to a possible entrapment the mattress support platform should be left in the flat position whilst unattended
- To ensure safe functioning of the bed electronics, the electronic system must be reset when any changes are made to it

Changes are defined as:

Mains power is lost (power outage, turned off/on, mains cable is unplugged component cabling is disconnected from or connected to the control box or junction box
Refer to section 6.4 to complete the electronic system reset

5. OVERVIEW

The Aidacare FL250 Bed has been designed specifically for the aged care and hospital environment. Please take the time to familiarise yourself with the key components shown below:

Available in single or king single widths (King single shown)

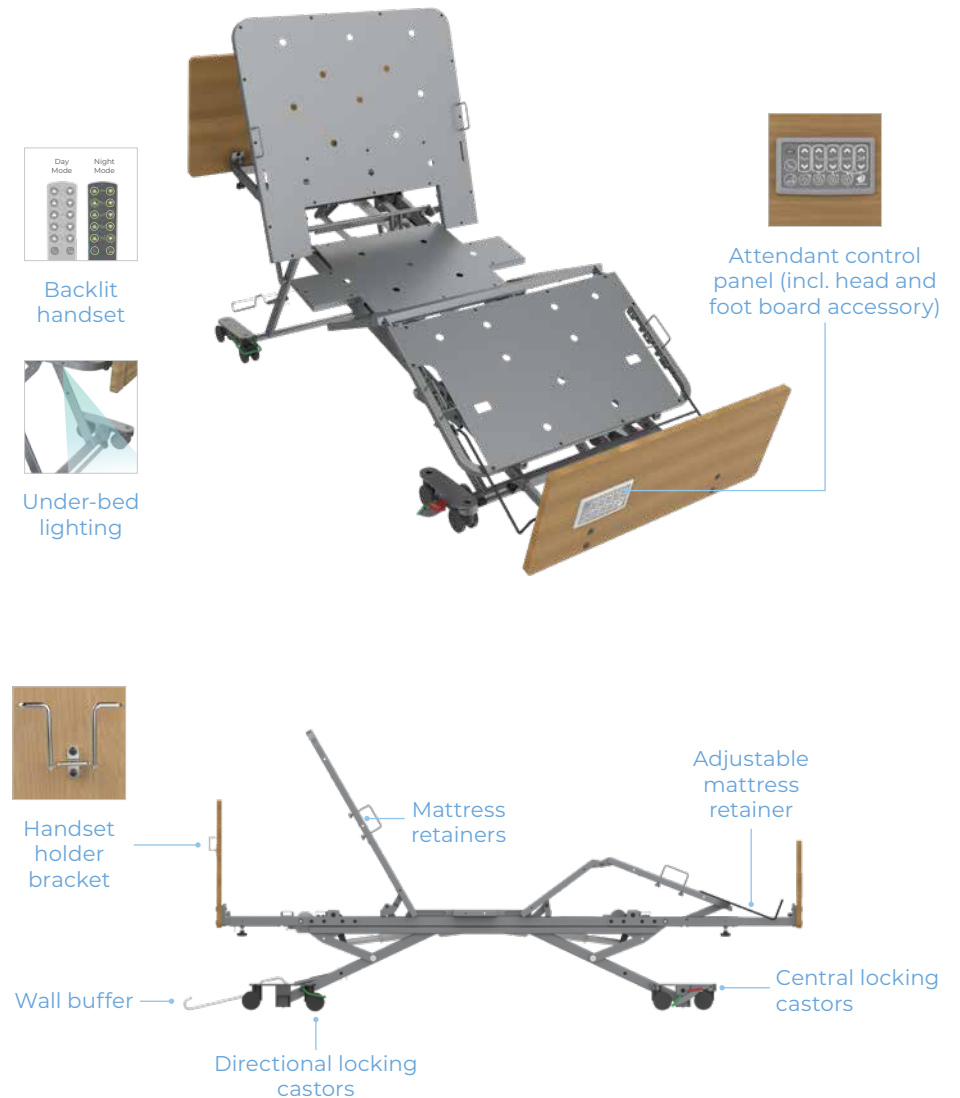

ALWAYS position the bed at its lowest height when unattended by caregivers to minimise the risk of patient injury from falls when getting in and out of the bed



ALWAYS use the **ExitSafe** Button whenever the patient is entering or exiting the bed to ensure transfers are completed at a safe height to minimize falls risk



ALWAYS use a mattress of appropriate size and type. A range of suitable pressure reducing and pressure relieving mattresses are also available from Aidacare



ALWAYS make sure that the patient is safely positioned to avoid entrapment before operating the bed



ALWAYS ensure that attendant and patient limbs are free from potential entrapment areas before operating any functions



ALWAYS use the **ExitSafe** Button when treating a patient or transporting the bed to avoid unnecessary bending/stooping by care staff



ALWAYS apply the brakes when the bed is stationary



ALWAYS store the handset when not in use to avoid accidental operation of the beds functions. The handset can be stored by hooking it on to the side rail of the bed or positioning it in the handset holder bracket



ALWAYS ensure that all drips and drains (hospital lines) and power cables are free from possible entanglement with mechanical parts of the bed



ALWAYS transport/relocate beds using the EasyMove Transport System when uninhabited. This enables lift free transportation and reduces manual handling risks to staff



DO NOT place the handset, or power cord across the mattress surface of the bed when the bed is not connected to mains power. Always store the power cord using the fastening straps provided



DO NOT use electrically operated beds in the presence of flammable gases



DO NOT use the bed to support more than one patient. FL250 Beds are intended for single person use and may become unstable if used incorrectly. Usage outside of intended design will void all warranties associated with this product



DO NOT use accessories that are not designed, or approved for use with FL250 Beds

6. SPECIFICATIONS

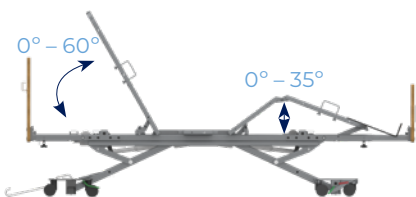

NOTE: Backrest and knee bend angle is the same across both Single and King Single beds

Dimensions

	Overall Length	Overall Width	Overall Height	SWL
Single:	2288mm / 90"	900mm / 35.4"	110-740mm / 4.3"-29"	250kg / 39.4st
King Single:	2288mm / 90"	1060mm / 41.7"	110-740mm / 4.3"-29"	250kg / 39.4st

Mattress Size

MODEL	Single	King Single
Recommended Mattress Size	Width = 900mm / 35.4"	Width = 1060mm / 41.7"
Maximum Mattress Depth	Length = 2000mm / 78.7"	Length = 2000mm / 78.7"
	Depth = 170mm / 6.7"	Depth = 170mm / 6.7"

Bed Weight & Safe Working Load

Bed Weight – Single	105kg / 231lb
Bed Weight – King Single	115kg / 254lb
SWL (Safety Factor 2 x SWL)	250kg / 39.4st
Max User Weight	200kg / 31.5st (makes allowance for accessories like mattresses, air mattresses and pumps, bed poles etc.)

Electrical Parameters

Power Input	230V AC 50Hz, Max current 1A
Rate Load	Interruption 10%, Max 2 minutes / 18 minutes
Leakage Protection	Class 1 Type B
Waterproof Grade	IP54

STANDARDS COMPLIANCE

Aidacare FL250 Beds are designed and manufactured where required in compliance with International Medical Device Safety standard IEC60601-1, IEC60601-2-52. All electronics are designed for use in Acute Care environments and comply with all relevant Electrical Safety Standards.

7. ACCESSORIES

A range of FL250 Bed accessories are available. In addition to the below listed accessories, Aidacare specialises in other complimentary products such as foam mattresses, pressure care surfaces, over bed tables, side lockers and adjustable day chairs. Please contact Customer Service on 1300 133 120 for further information.

Code	Description	
BEA030050	EasyMove Transport System <i>*Does not include bed shown</i>	
BEB046210	Bed End Set – Single – Tahoe – Teak	
BEB046220	Bed End Set – King Single – Tahoe – Teak	
BEB046210	Bed End Set – Single – Vail – Milano	
BEB046230	Bed End Set – King Single – Vail – Milano	
BEB046240	Bed Side Set – Tahoe – Teak	
GSP391630	Mounting Hardware – Single	
GSP391640	Mounting Hardware – King Single	
BEB046250	Bed Side Set – Vail – Milano	
GSP391630	Mounting Hardware – Single	
GSP391640	Mounting Hardware – King Single	
BEB048785	Full Length Rails – Set of 4 – Sublime Teak	
BEB048750	Bed End Set – Single – Sublime Teak	
BEB048770	Bed End Set – King Single – Sublime Teak	
BEB048790	Full Length Rails – Set of 4 – Milano Walnut	
BEB048755	Bed End Set – Single – Milano Walnut	
BEB048775	Bed End Set – King Single – Milano Walnut	
BEB048800	Telescopic Side Rails Full Kit – Sublime Teak	
BEB048805	Telescopic Side Rails Full Kit – Milano Walnut	

BEB048810 Telescopic Side Rails & Trim Full Kit – Sublime Teak
 BEB048815 Telescopic Side Rails & Trim Full Kit – Milano Walnut



BEB048820 Telescopic Side Rails & Trim Full Kit – Sublime Teak
 BEB048820 Telescopic Side Rails & Trim Full Kit – Milano Walnut



BEB046500 Width Extension Kit



BEB046520 Folding Assist Bar



BEB046525 Split Folding Grab Rails (Pair)



BEB046530 IV Pole



BEB046540 Self Help Pole



BEB046590 Battery Backup
 BEB046592



BEB046616 USB Port Upgrade Kit



WARNING

Do not use accessories that have not been designed for use with FL250 Beds

8. ELECTRONIC FUNCTIONS



WARNING

- Ensure the patient, caregivers and/or equipment is positioned to avoid being trapped or crushed during bed adjustment
- Ensure the power lead is not stretched excessively
- Ensure the handset and electrical leads cannot become entangled with moving parts of the bed
- DISCONNECT the power lead from the mains and stow before transporting the bed
- If the power lead shows any sign of damage, replace immediately
- Ensure safety key is removed when handset is not in use

8.1 HANDSET OPERATION

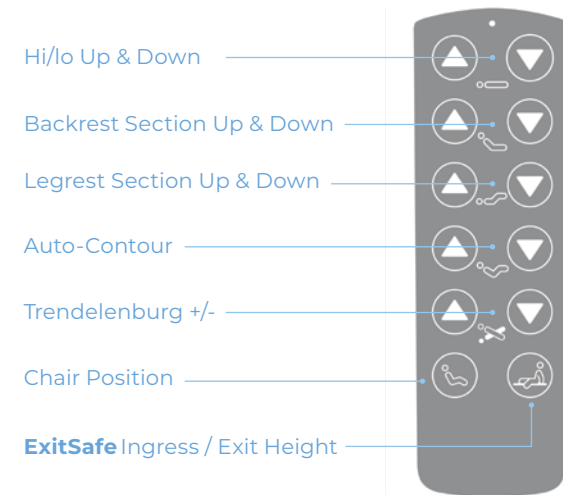

FL250 Beds are powered by four electric IP54 rated actuators, which are controlled by the Handset or Attendant Control Panel. Adjustment occurs only while a button is pressed. Adjustment will stop when the button is released, or the selection reaches the end of its range.

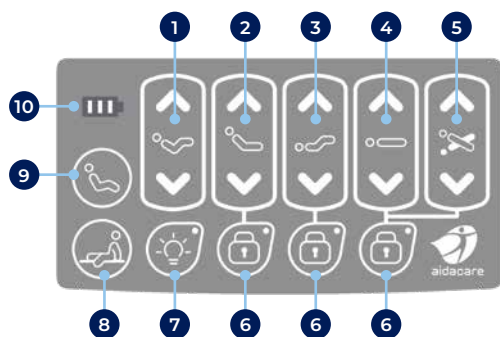

8.2 ATTENDANT CONTROL PANEL (ACP) OPERATION



- 1  **Auto-Contour:** Conveniently positions patient into cardiac chair position for therapeutic benefit and assists in preventing skin shear/patient sliding down the bed when raising backrest
- 2  **Backrest Section:** Controls the backrest angle from horizontal up to a maximum of 60°
- 3  **Knee Break Section:** Allows for knee positioning up to 35° for increased user comfort and pressure therapy relief. The ratchet legrest can also be enabled by hand to further increase comfort
- 4  **Hi/lo with SmartDescent:** Positions the bed to the desired height from 110-740mm / 4.3"-29". The bed automatically halves its rate of descent from 300mm / 12" to lowest position to minimize the risk of entrapment or damage to low lying items such as mattress pumps
- 5  **Trendelenburg +/- :** Facilitates overall +ve or -ve tilting of the bed from -14° to 14° from horizontal
- 6  **Patient Lock Out:** Locks handset out of specific function
- 7  **Underbed Light:** Creates a subtle glow on the floor near the bed end for carers and users during the night
- 8  **ExitSafe Ingress / Exit Height:** Flattens the mattress surface and then raises the bed to the optimal height for entry/exit from the bed. This height is ideal for manutention/manual handling by carers and also facilitates CPR if required

- 9  **Chair Position:** Raises backrest and legrest into cardiac chair orientation and then tilts bed forward into an upright dining position
- 10  **Battery Power Indicator:** Illuminates on start-up, but thereafter only if optional battery backup is installed



Care should be taken whilst operating the bed functions to ensure hands and fingers are free from potential squeeze hazards

8.4 RESETTING THE ELECTRONIC SYSTEM

To ensure safe functioning of the bed electronics, the electronic system must be reset when any changes are made to it.

Changes are defined as:

- mains power is lost (power outage, turned off/on, mains cable is unplugged)
- component cabling is disconnected from or connected to the control box or junction box

To complete the reset procedure, simultaneously press hi lo up and hi-lo down buttons for 5 seconds. Continue pressing while the bed moves on its own (and calibrating the system) until the bed stops moving and the handset top LED flashes 3 times.

The electronic system is now reset.

9. ASSEMBLY

9.1 FL250 BED ASSEMBLY

The FL250 Bed comes securely packaged in a cardboard carton. The outside of the carton is protected by corner and centre stabilisers for rigidity to avoid compression and damage in shipping. Inside the carton you will find protective foam covering the wheels and mattress surface while the bed frame is also wrapped for further protection. The FL250 Bed should arrive to you in pristine condition, ready for immediate assembly and installation.

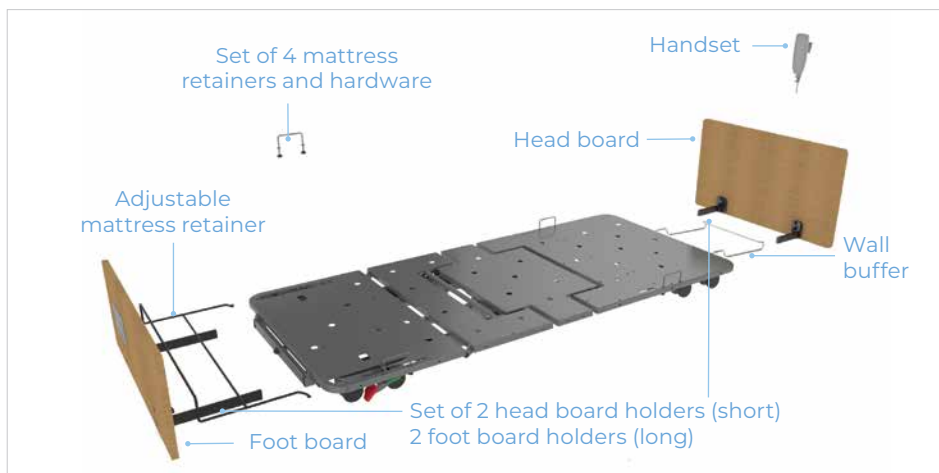

Carton Contents:

- 1 x FL250 Bed
- 1 x Set of 4 Mattress Retainers and hardware
- 1 x Adjustable Mattress retainer
- 1 x Wall Buffer
- 1 x Handset
- 1 x Set of 2 Head Board Holders (short) + 2 Foot Board Holders (long)
- 1 x Head Board (Sold Separately)
- 1 x Foot Board (Sold Separately)



The FL250 Bed is a large piece of advanced medical equipment requiring special attention and careful handling at all times

Depending on the situation, appropriate powered or manual lifting, handling or moving assistance equipment includes but is not limited to:

- FL250 EasyMove Transport System (Optional – BEA030050)
- Forklift
- Walkie Stacker
- Hydraulic Pallet Jack
- Hydraulic Lift Trolley
- Goods Trolley
- Tail Gate Loader



ALWAYS use appropriate manual and powered handling techniques and equipment, including the EasyMove Transport System



ALWAYS be aware of sharp items in packaging materials, handle and dispose or recycle appropriately



ALWAYS wear appropriate protective clothing and eye goggles



ALWAYS use cut-proof gloves when handling or cutting steel or plastic carton strapping



DO NOT attempt to lift an FL250 Bed manually without appropriate equipment

(A) ASSEMBLY OF FL250 BED

(with access to power source)

Unpack Bed, Plug In And Raise

1. Using appropriate equipment lower the bed carton onto a hard flat surface
2. Carefully remove strapping and external dunnage materials, remove the carton lid and remove internal dunnage materials
3. Locate all component packets as per carton contents
4. Flatten the sides of the carton base
5. Plug in Power Lead. To locate it, tilt up the mattress platform head section. Undo Velcro strap to release the power lead

Note: Beds with serial number FL250-V2-2204-00000 onwards allow for the power cord to be extended if required.

To extend the power cord:

- a. Lift the backrest to its maximum height
- b. Locate ① the power cord, ② the zip tie holding it to the frame and ③ the cable gland. Cut the zip tie to release the power cord
- c. Loosen the cable gland and pull the power cord out as desired
- d. Tighten cable gland to lock cable in place
- e. Test bed through both its hi-lo and backrest movement range and ensure the power cord does not get pinched or crushed by the frame. Any excess and loose power cord remaining between the cable gland and control box must be secured to the frame to prevent unintentional movement

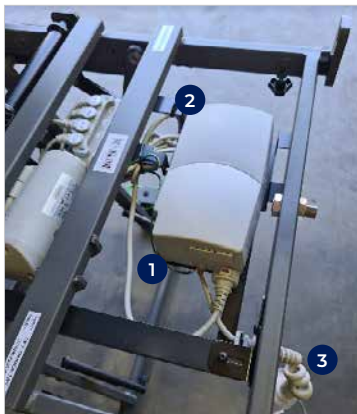

6. Plug the handset into the ACP port, wait 5 seconds. To locate the ACP port, tilt up the mattress platform foot section
7. Ensure the bed is free of encumbrance or obstacles – press the hi/lo up/down button on the handset and raise the bed to an appropriate height (600 to 700mm recommended) so as to fit Mattress Retainers, Head & Foot Board Holders and Wall Buffer
8. Unplug handset from ACP port, plug into 1 of 2 handset port options located at left or right side, mid bed

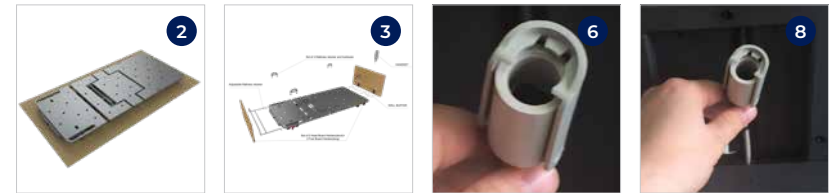

Mount Mattress Retainers:

9. Unpack the set of Mattress Retainers and hardware
10. Insert vertically through holes on the Mattress Platform sides. Fasten firmly with hand from beneath



Mount Adjustable Mattress Retainer (Foot End):

11. Unpack the Adjustable Mattress Retainer
12. Hold vertically and insert flat ends into 1 of the 3 receiving keyhole mounts which are 100mm / 4" spaced at the foot end of the mattress platform to match the desired bed extension (nil, 100mm / 4", 210mm / 7.9"). Lower the retainer to the mattress platform. It will now be locked in place at the mount keyholes



Mount Head and Foot Board Holders:

13. The LONG pair goes at the FOOT end
14. The SHORT pair goes at the HEAD end
15. Ensure the mounting bracket end of each Holder is facing inwards
16. Loosen the hand wheel on the inside of the bed frame which are located on both the left and right sides of the bed, at the foot and head ends of the bed
17. Each Holder shaft has pre-stamped locator points, insert the shaft into the bed frame until you feel or hear a click – which is the bed frame lining up with the shaft locator point
18. Fasten each Holder at the locator points by tightening the hand wheel on the bed frame. This ensures greater stability and rigidity of the Head & Foot Boards

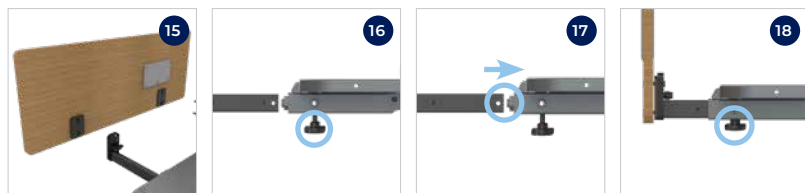

Remove Bed From Base Carton

19. Unlock central locking brake at the foot end by pressing the green pedal
20. Roll the bed out of the flattened carton and position or move the bed as desired
21. Remove remaining dunnage and wrapping and other materials such as protective foam and zip ties



Mount the Wall Buffer:

22. When the bed is in the desired position, attach the wall buffer at the head end of the bed
23. Locate the sprung mounting barrels on the head end bed legs, loosen the thumb screws for insertion of wall buffer
24. Ensuring the hooked end of the wall buffer is pointing upwards, insert the ends of the wall buffer into the sprung mounting barrels. Ensure fully inserted
25. Fasten thumb screws tightly to secure wall buffer



Position the bed:

You may position the bed as desired however it is recommended that if the head end is positioned against a wall, the wall buffer should be in contact with both the floor and wall or skirting board.

26. If necessary, gather and fasten excess ACP or power leads away from encumbrance with moving parts

(B) ASSEMBLY OF FL250 BED

(without access to power source)

Unpack Bed, Mount To EasyMove Transport System

1. Using appropriate equipment (such as forklift, walkie stacker, pallet jack, hydraulic lift trolley etc) lower the bed carton to 600-700mm / 23.5"-27.5" from the ground
2. Carefully remove strapping and external dunnage materials, remove the carton lid and internal dunnage materials
3. Fold down carton base to expose either end of bed
4. Place an EasyMove trolley at either end of the bed. The narrower width base castors of the EasyMove face in towards the bed
5. Lower the bed until the bed frame axle mount is level with the EasyMove quick release axle
6. Attach bed to EasyMove Transport System (as per EasyMove instructions – see page 39)
7. Remove lifting device
8. Remove remaining carton and dunnage materials
9. Locate all component packets as per carton contents above
10. Plug in handset to 1 of 2 handset port options
11. Mount mattress retainers
12. Mount adjustable mattress retainer (foot end)
13. Mount Head and Foot Board Holders
14. Hang hooked end of Wall buffer over EasyMove handle crossbar
15. Pivot the bed frame to vertical (as per EasyMove instructions – see page 39)

The bed is now ready to move to a power source.

When a power source is reached, pivot the bed to horizontal, plug in the power lead, lower legs to floor and disconnect EasyMove Transport System (as per EasyMove instructions – see page 39)

16. Mount the Wall Buffer
17. Position the bed
18. If necessary, gather and fasten excess ACP or Power Leads away from encumbrance with moving parts



9.2 HEAD AND FOOT BOARD ASSEMBLY

The FL250 Bed Head and Foot Board attachment system is designed to allow quick and secure fitting of factory model FL250 Head and Foot Board options, as well as customised options to suit any interior design specifications

Carton Contents:

- 1 x Pair Head + Foot Board – size and colour is SKU dependent
- 1 x Attendant Control Panel (ACP) and Lead – pre-fitted
- 1 x Set of 2 Head Board holders + 2 Foot Board holders – pre-fitted
- 1 x Handset Holder Bracket and Hardware

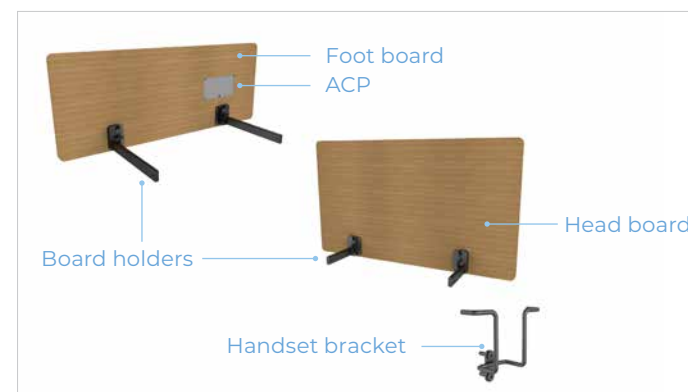

Assembly of Head and Foot Boards

Head and Foot Boards come pre-assembled so this process simply involves fastening the Head and Foot Boards to the bed frame.

1. Locate the Head and Foot Board Holders at either end of the bed frame
2. Ensure the Board holders face inwards
3. Hold the Head Board horizontally upright
4. Line up the Head Board Holder Pegs with the Head Board Holder keyholes
5. Insert, ensuring both sides are fully inserted, push the Head Board down so the pegs drop into the bottom of the Holder keyholes
6. Fasten the thumb screw on each Holder firmly
7. **NOTE:** leave the Head Board Holders extended from the bed frame to allow easy access and handling of the thumb screws. Once thumb screws are fastened, push Head Board into desired length until the Holder Shaft finds the locator point
8. Tighten Head Board Holder hand wheels until very firm
9. Repeat the same process for Foot Board
10. Plug ACP Lead into ACP port. To locate the ACP port, tilt up the mattress platform foot section
11. Affix Handset Holder Bracket with the self-tapping screws that are provided. Align vertically and locate as desired – usually this is the wall facing side of headboard on the side closest to the room entry door. You may choose for the top of the handset to be visible above or hidden behind the Head Board
12. If necessary, gather and fasten excess ACP away from encumbrance with moving parts

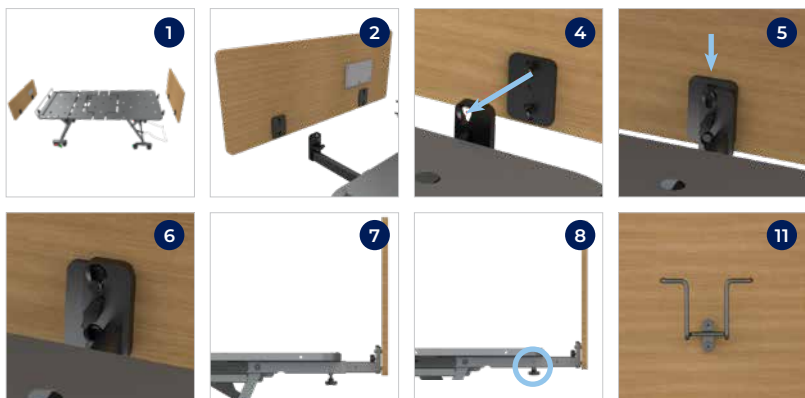

9.3 SIDE PANEL ASSEMBLY

The FL250 Side Panels are designed to match the FL250 Head and Foot Board options for a complete surround finish. They can also be customised to match customised Head & Foot Boards to suit any interior design specifications.

The FL250 Side Panels are designed to move independently with each bed platform section they are attached to.

IMPORTANT: The attachment hardware required for the FL250 Side Panels is different for Single vs King Single FL250 Beds. Therefore TWO items or SKU's must be supplied / sold to correctly fit the Side Panels:

1. Side Panels (colour dependent); plus either
2. a – Single Hardware; or
b – King Single Hardware

Carton Contents FL250 Side Panels – 8 piece set includes:

- 1 x HEAD section LEFT (longest) – unique to this section and side
- 1 x HEAD section RIGHT (longest) – unique to this section and side
- 2 x MID section LEFT/RIGHT (shortest) – fits left/right side of this section
- 2 x KNEE section LEFT/RIGHT (second shortest) – fits left/right side of this section
- 1 x FOOT section LEFT (second longest) – unique to this section and side
- 1 x FOOT section RIGHT (second longest) – unique to this section and side

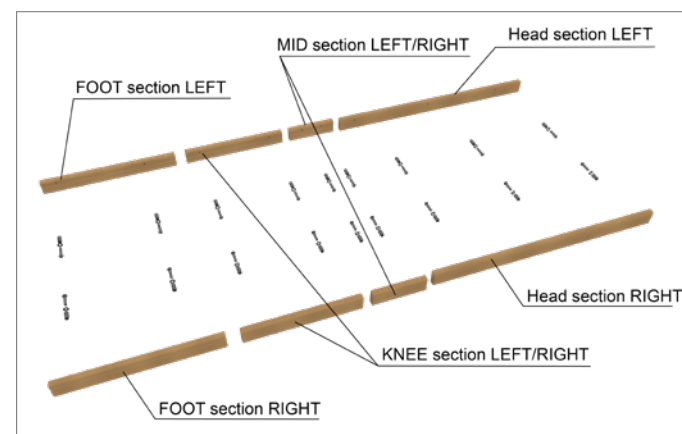

Item 2a – Hardware for Single Bed:

- 18 x Attachment Bolts and Washers

Item 2b – Hardware for King Single Bed:

- 18 x Attachment Bolts and Washers; and
- 18 x Spacers

Recommended Tools

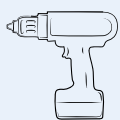

Power Drill

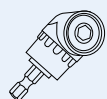

Right Angled
Power Drill Adaptor

Fastening Side Panels to the FL250 Bed Frame

1. For best access to the bed frame sides for attaching panels, use the FL250 EasyMove Transport System and pivot the bed vertically
2. Ensure the panels are matched to the correct platform section and left/right side as per the list above – some are unique to SECTION AND LEFT/RIGHT side
3. Place the panel on the matching platform section. The top of the panel should be flush with the top of the mattress platform
4. Line up the panel nutserts with the holes in the bed frame
5. Insert the washer (followed by spacer if a King Single Bed) onto the bolt
6. Insert the bolt through the hole and screw into panel nutsert
7. Fasten firmly – use a right angle power drill adaptor for easier access to the bolt head, apply high torque
8. Repeat for all panels – check to ensure all are correctly attached upon completion

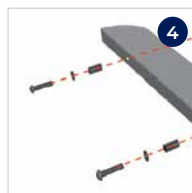

9.4 FULL LENGTH SIDE RAILS ASSEMBLY

Full Length Rails – Set of 4

[BEB048785](#) Sublime Teak | [BEB048790](#) Milano Walnut

Bed End Set – Single

[BEB048750](#) Sublime Teak | [BEB048755](#) Milano Walnut

Bed End Set – King Single

[BEB048770](#) Sublime Teak | [BEB048775](#) Milano Walnut

Recommended Tools



Phillips head
screwdriver



3mm Allen Key

FL250 full length side rails are designed to provide a safety barrier to minimise the risk of a resident falling from the bed. These are supplied as a full kit and cannot be used with standard head and foot boards.

Carton Contains:

As rails and bed ends are packaged separately, a full kit contains 2 x cartons.

Bed End Set (Carton 1)

- 1 Headboard
- 2 Footboard
- 3 2 x Head end board holders (short)
- 4 2 x Foot end board holders (long)

Full Length Rails Set (Carton 2)

- 5 4 x Wire guides
- 6 4 x End caps – Top
- 7 4 x End caps – Bottom
- 8 4 x Full length rails

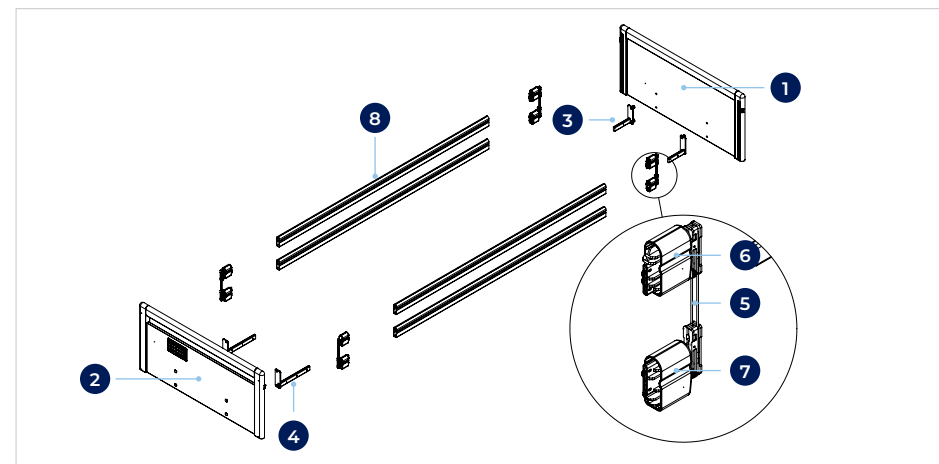

Assembly of the full length rails

1. Remove existing head and foot boards and board holders from bed (if fitted) and put aside



2. Assemble the board holders 3 & 4 to the new headboard 1 and footboard 2 for full length rails. Ensure the Board holders are orientated towards each other as shown and are mounted to the same side of the board as the aluminium tracks



WARNING

DO NOT over tighten the bolts as this could damage the boards.

3. Insert new headboard 1 and footboard 2 onto the bed leaving a 10mm gap between the board and transport trolley receiver nut



4. Assemble the plastic end caps 6 & 7 and wire guide 5 as shown. Ensure that the top cap 6 slides up and down the wire easily. If assembly is correct top and bottom caps will not touch
5. Repeat step 4 until all four assemblies have been completed

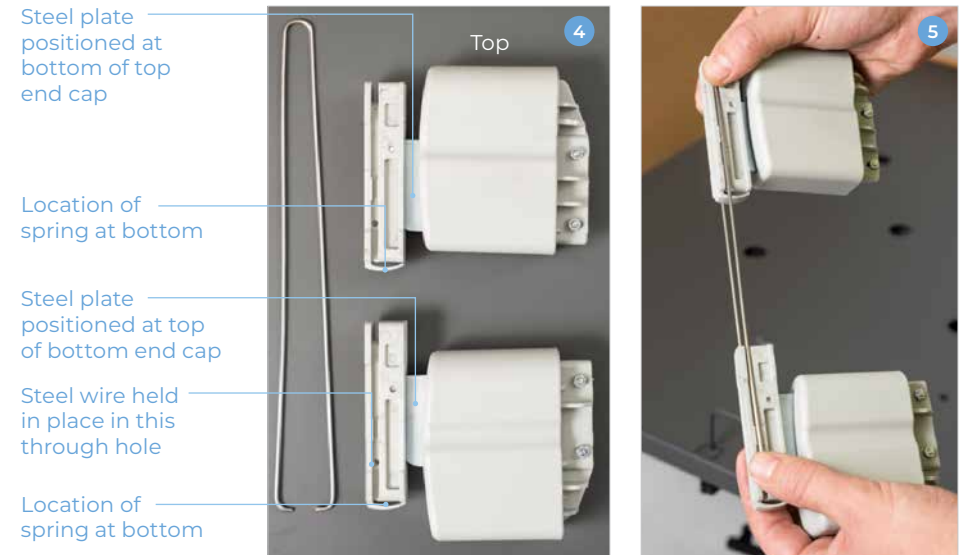

6. Remove the bolt and spacer from the bottom of each of the four aluminium tracks
7. On the headboard 1, slide plastic cap assemblies into the aluminium track and all the way to the top
8. Replace the bolt and spacer at the bottom of the track of the headboard 1 to prevent the end caps from falling out

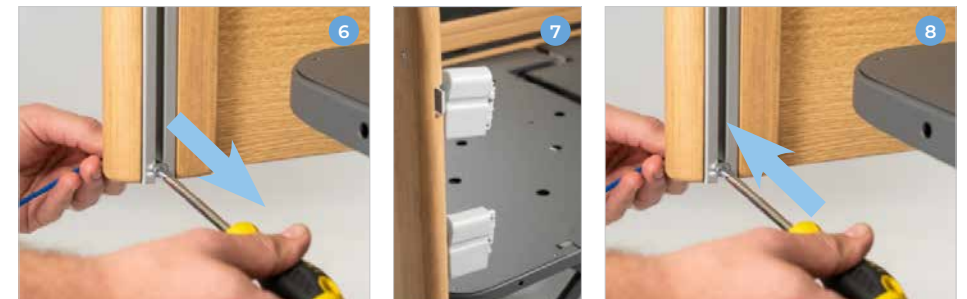

9. On the headboard ①, release the end cap assemblies by raising the top end cap ⑥ slightly and pressing the button. Let the end cap rest in the down position
10. Slide the footboard end caps ④ on to the rail ensuring correct orientation. Finally slot the rail ⑧ into end caps already on the headboard ①



11. Slide the foot end cap ⑦ assemblies into the foot board ②. Slide rails all the way to the top and lock in place. Ensure wire ⑤ does not come loose during this step
12. Replace the bolt and spacer at the bottom of the track for the foot board ⑤

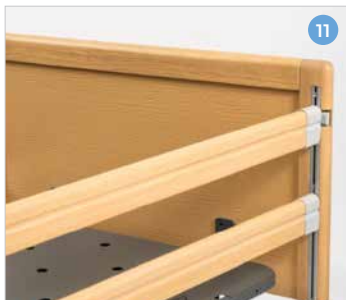

13. Repeat steps ⑨ to ⑫ for other side of the bed
14. Assembly is now complete

9.5 SELF HELP POLE AND IV POLE ASSEMBLY

The Self Help Pole (SHP) provides an overhead patient support or manoeuvring handle to assist with repositioning. The IV Pole provides a telescoping height adjustable hanger for tubes, bags and other equipment.

The FL250 Self Help Pole and FL250 IV Pole are designed to attach to the FL250 Head Board and therefore will move with any Head Board movement – up, down, tilt etc.



Be aware of encumbrances such as walls, cupboards, curtains, lights etc when manoeuvring the bed with a Self Help Pole or IV Pole attached. Pay particular attention when tilting the bed or using the Trendelenburg or reverse Trendelenburg functions

Carton Contains – FL250 Self Help Pole:

- 1 x Self Help Pole in 2 sections, top and base (8 x joining bolts mounted to top section)
- 1 x Handle with Strap
- 1 x SHP attachment and receiver bracket

Carton Contains – FL250 IV Pole:

- 1 x Telescoping IV Pole
- 1 x IV Pole attachment and receiver bracket

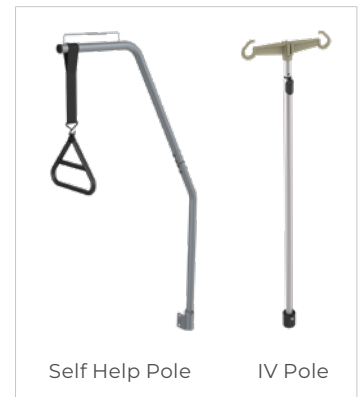

Assembly of the FL250 Self Help Pole

1. Remove 8 bolts from top section
2. Join top section with base section, insert and fasten all 8 bolts firmly
3. Remove the Head Board from the bed
4. Choose which side of the Head Board to mount the SHP on – left or right
5. Undo the left or right Head Board attachment bracket screws and remove the outside plate
6. Position the SHP attachment and receiver bracket over the Head Board holes and attach using Head Board Attachment Bracket screws just removed
7. Fasten until very firm. This also re-affixes the Head Board attachment bracket
8. Reinstall the Head Board back onto the bed

9. Insert base of SHP into the receiver and position so the peg on the SHP sits in the slot of the receiver
10. SHP will now sit securely in place
11. SHP position can be altered by lifting and twisting to the second notch position



Assembly of the FL250 IV Pole

1. Choose which side of the Head Board to mount the IV Pole on – left or right
2. Undo the left or right Head Board attachment bracket screws and remove the outside plate
3. Position the IV Pole attachment and receiver bracket over the head board holes and attach using Head Board Attachment Bracket screws just removed
4. Fasten until very firm. This also re-affixes the Head Board attachment bracket
5. Reinstall the Head Board back onto the bed
6. Insert base of IV Pole into the receiver and position so the peg on the IV Pole sits in the slot of the receiver
7. IV Pole will now sit securely in place
8. IV Pole position can be altered by lifting and twisting to the second notch position
9. IV Pole height can be adjusted via the telescoping shaft



9.6 KING SINGLE CONVERSION KIT ASSEMBLY

The FL250 King Single Conversion Kit is designed to retrofit a Single FL250 bed into a King Single.

King Single FL250 beds are available separately (BEB046150).

Each kit section attaches to a platform section of the bed, increasing the bed width from 900mm (Single) to 1070mm (King Single).

Carton Contents:

- 1 x HEAD section LEFT (longest) – unique to this section and side
- 1 x HEAD section RIGHT (longest) – unique to this section and side
- 2 x MID section LEFT/RIGHT (shortest) – fits left/right side of this section
- 2 x KNEE section LEFT/RIGHT (second shortest) – fits left/right side of this section
- 1 x FOOT section LEFT (second longest) – unique to this section and side
- 1 x FOOT section RIGHT (second longest) – unique to this section and side
- Bolts, washers & spacers

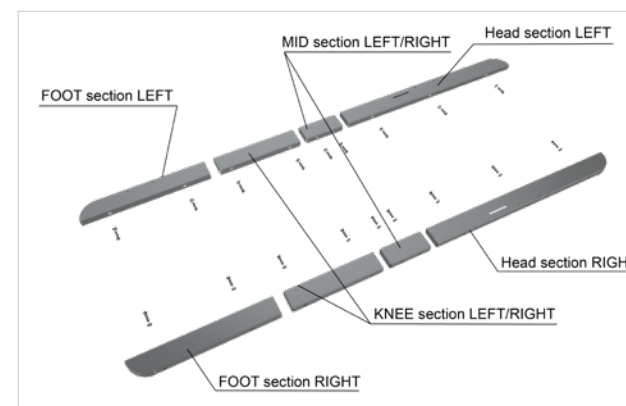

NOTE: If Side Panels are already fitted to the single bed, they must be removed before the King Single Conversion Kit can be attached.

Recommended Tools

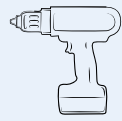

Power Drill

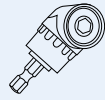

Right Angled
Power Drill Adaptor

Fastening King Single Conversion Kit to the FL250 Bed Frame

1. For best access to the bed frame sides to attach the kit sections, use the FL250 EasyMove Transport System and pivot the bed vertically
2. Ensure the kit sections are matched to the correct platform section and left/right side as per the list above – some are unique to SECTION AND LEFT/RIGHT side
3. Place the kit section on the matching platform section. The top of the kit section should be flush with the top of the mattress platform
4. Line up the kit section bolt holes with bed frame bolt holes
5. Insert the bolt and washer and fasten
6. Fasten firmly – use a right angled power drill adaptor for easier access to the nut head, apply high torque
7. Repeat for all kit sections – check to ensure all are correctly attached upon completion

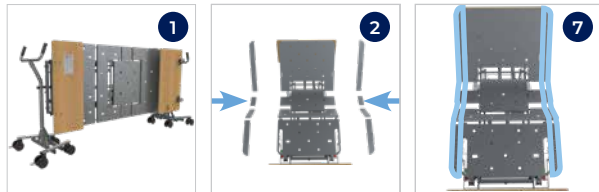

9.7 FOLDING ASSIST BAR INSTALLATION

The FL250 Folding Assist Bar is designed to provide self-support and assistance for positioning and movement within the bed, as well as when getting into and out of the bed.

The Folding Assist Bar is able to be neatly tilted down to parallel with the side of the bed when it is not required, or if it is preferred to be out of the way of transfers in or out of bed.

IMPORTANT: The attachment hardware required for the FL250 Side Panels is different for Single vs King Single FL250 Beds. Therefore TWO items or SKU's must be supplied / sold to correctly fit the Side Panels:

Carton Contents – 2 piece set includes:

- 1 x folding assist bar. 2 x bolts attached to folding bar base
- 1 x flat mounting plate. 2 x bolts, bushes and dome nuts – attached to plate

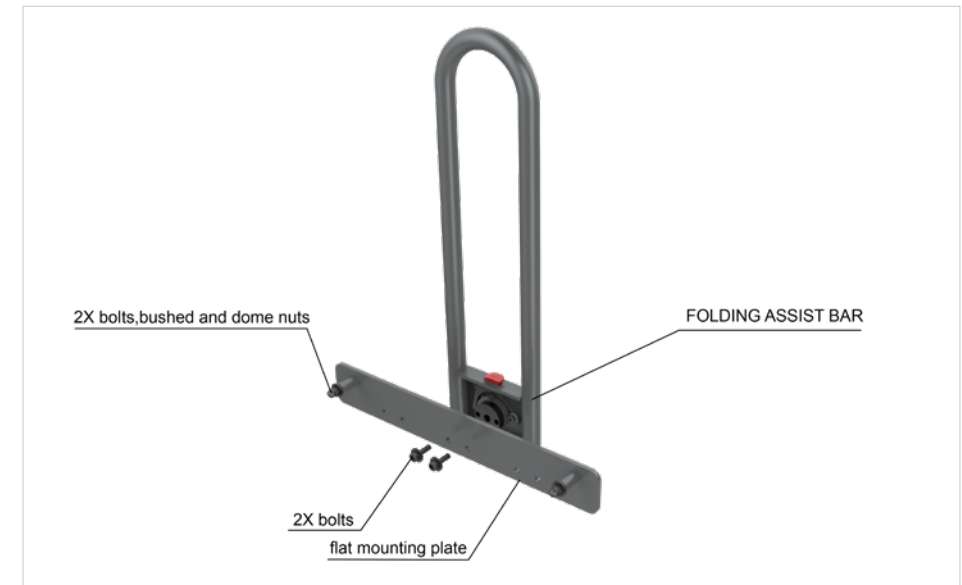

NOTE: If side panels are already fitted to the bed, they must be removed before the folding assist rail can be attached. They need to be removed from the entire bed or just the panel where the folding assist rail is wanting to be attached.

Recommended Tools

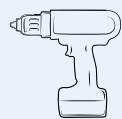

Power Drill

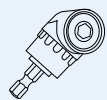

Right Angled
Power Drill Adaptor

Fastening Folding Assist Bar to Bed

1. For best access to the bed frame side to attached the Folding Assist Bar, use the FL250 EasyMove Transport System and pivot the bed vertically
2. The Folding Assist bar attaches to the Head Section (left or right)
3. Remove the 2 bolts from the rotation plate at the base of the folding bar
4. Attach the folding bar to the mounting plate with these 2 bolts. Fasten tightly
5. Remove the bolts, bushes and dome nuts from the mounting plate (now with folding bar attached)
6. If mounting to a King Single bed – use the bushes supplied. For a single bed only the bolts and washers supplied are required
7. Place the mounting plate onto the bed frame (Head Section) and line up the bolt holes (2) with the bed frame holes. It can be placed in 1 of 2 positions on the Head Section of the frame
8. Insert the bolts (and bushes if KS bed) and fasten dome nuts on inside of bed frame
9. Fasten firmly – use a right angle power drill adaptor for easier access to the dome nut, apply high torque
10. Press the red button on the folding bar to release and fold down gently. When the bar is parallel to the bed frame it will stop in this position
11. To raise the bar, pull it up by hand

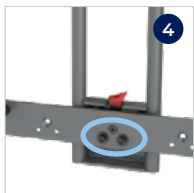
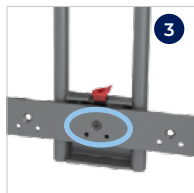

9.8 SPLIT FOLDING GRAB RAILS ASSEMBLY

The FL250 Split Folding Grab Rails are designed to provide self-support and assistance for positioning and movement within the bed.

The FL250 Split Folding Grab Rails are supplied as a left/right pair and require installation on the bed.

Carton Contents – 2 piece set includes:

- 1 x Split Folding Grab Rail with mounting plate – LEFT. 3 x bolts, bushes and dome nuts on mounting plate
- 1 x Split Folding Grab Rail with mounting plate – RIGHT. 3 x bolts, bushes and dome nuts on mounting plate

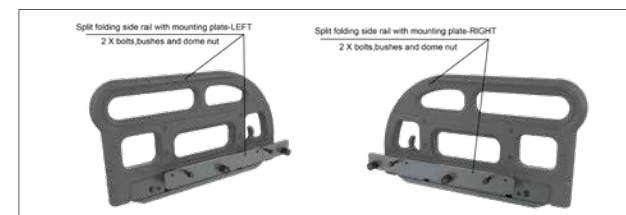

NOTE: If side panels are already fitted to the bed, they must be removed before the folding grab rail can be attached. They need to be removed from the entire bed or just the panel where the folding Grab Rail is wanting to be attached.

Recommended Tools

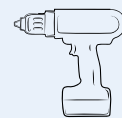

Power Drill

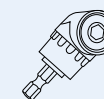

Right Angled
Power Drill Adaptor

Fastening Split Folding Grab Rails to Bed

1. For best access to the bed frame side to attach the Split Folding Grab Rails, use the FL250 EasyMove Transport System and pivot the bed vertically
2. The Split Folding Grab Rail is attached to the Head Section of the bed
3. The tapered end of the Split Folding Grab Rails with the release switch faces towards the foot end of the bed, as shown
4. Remove the 3 x bolts, bushes and dome nuts from the mounting plate

5. If mounting to a King Single bed – use the bushes supplied. For a single bed only the bolts and washers supplied are required
6. Place the mounting plate onto the bed frame (Head Section) and line up the bolt holes with the bed frame hole. Insert the bolts (and bushes if KS bed) and fasten dome nuts on inside of bed frame
7. Fasten firmly – use a right angle power drill adaptor for easier access to the dome nut, apply high torque
8. Press the release lever within the rail to release and fold down gently. When the base of the rail is parallel to and alongside the bed frame it will stop in this position
9. To raise the rail, release the lever and pull it up by hand until it clicks into the up position



9.9 TELESCOPIC RAILS ASSEMBLY



ALWAYS use the mounting bar for the Telescopic Side Rails



WARNING

Blue handset (BEB046602) must be used with Telescopic Side Rails

Kit Options (Bed NOT included)

Kits contain all parts required to fit a full bed. Choose a telescopic side kit and bed end to complete a set.

Telescopic Side Rail Kits (Choose one of the below options)

BEB048800	Sublime Teak	Telescopic Side Rails Full Kit 2 x 1/3 Rail	
BEB048805	Milano Walnut	2 x 2/3 Rail	
BEB048810	Sublime Teak	Telescopic Side Rails & Trim Full Kit 2 x 1/3 Rail	
BEB048815	Milano Walnut	2 x 2/3 Decorative Trim	
BEB048820	Sublime Teak	Telescopic Side Rails & Trim Full Kit 2 x 2/3 Rail	
BEB048820	Milano Walnut	2 x 1/3 Decorative Trim	





Bed Ends (Choose one of the below options)

BEB048830	Sublime Teak	Bed End Set – Single	
BEB048835	Milano Walnut	For Telescopic Rails – Como R	
BEB048840	Sublime Teak	Bed End Set – King Single	
BEB048845	Milano Walnut	For Telescopic Rails – Como R	





Customisation

The customisation option allows customers to choose what they need.

Mandatory (Required to fit and use side rails - Select either single or king single bed ends)

BEB048900		Mounting Bar & Hardware – Pair	
BEB046602	Blue	Hand Control – Min Height Limiting	
BEB048830	Sublime Teak	Bed End Set – Single	
BEB048835	Milano Walnut		
BEB048840	Sublime Teak	Bed End Set – King Single	
BEB048845	Milano Walnut		

Optional

BEB048850	Sublime Teak	Telescopic Rail 1/3 Length – EACH	
BEB048855	Milano Walnut		
BEB048860	Sublime Teak	Telescopic Rail 2/3 Length – EACH	
BEB048865	Milano Walnut		
BEB048870	Sublime Teak	Telescopic Rail – Decorative Trim 1/3 Length – EACH	
BEB048875	Milano Walnut		
BEB048880	Sublime Teak	Telescopic Rail – Decorative Trim 2/3 Length – EACH	
BEB048885	Milano Walnut		

Carton Contents – Mounting Bar & Hardware (PAIR):

1. End mounting bracket (x4)
2. Centre mounting bracket (x2)
3. Mounting rail (x2)

Carton Contents – Side Rails / Trim:



4. Telescopic side rail 1/3 length (x2) OR Decorative trim 1/3 length (x2)
5. Telescopic side rail 2/3 length (x2) OR Decorative trim 2/3 length (x2)

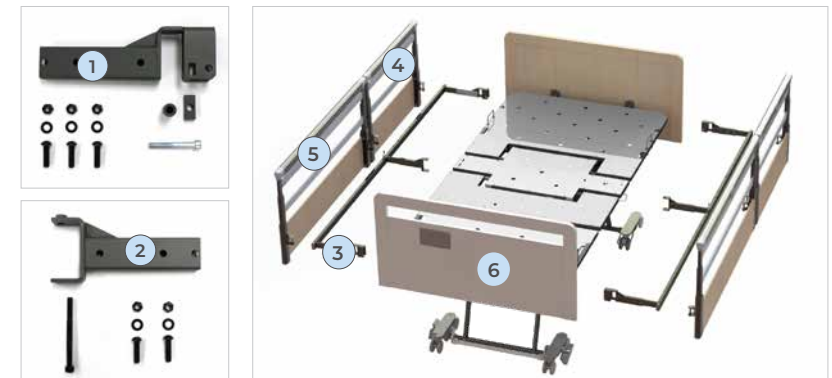

Carton Contents – Bed Ends:

6. Bed End Set Single OR Bed End Set King Single



Recommended Tools

-  Allen Keys (Size 5 & 6)
-  Socket Wrench (Size 13)

-  Drill
-  6mm drill bit

GENERAL ASSEMBLY

1. Remove all head and footboards from the bed, raise the bed to a comfortable working height and raise the backrest and leg rest to the maximum height
2. Install end mounting brackets to the head and foot ends of the frame. **DO NOT** tighten circled bolts completely
3. Install centre mounting bracket to the middle of the bed as shown. **DO NOT** tighten the bolt completely
4. Insert mounting rails into the end and centre mounting brackets at the same time
5. Align holes based on the bed size. Refer to the images shown for SINGLE and KING SINGLE rail configurations
6. Secure mounting rails with bolts
7. Tighten all remaining bolts on mounting brackets
8. Secure mounting rails to the centre of the bed frame with the countersunk bolt. For serial numbers before 2308-21063 (King Single) and 2307-30873 (Single), a hole will need to be drilled in place
9. Assemble the Telescopic side rails or decorative trim on to mounting rails. Ensure holes line up with both parts and secure with the provided bolts
10. Assemble Head and Foot boards to the bed
11. Replace the standard FL250 handset with a Blue handset to limit low height
12. Assembly is now complete

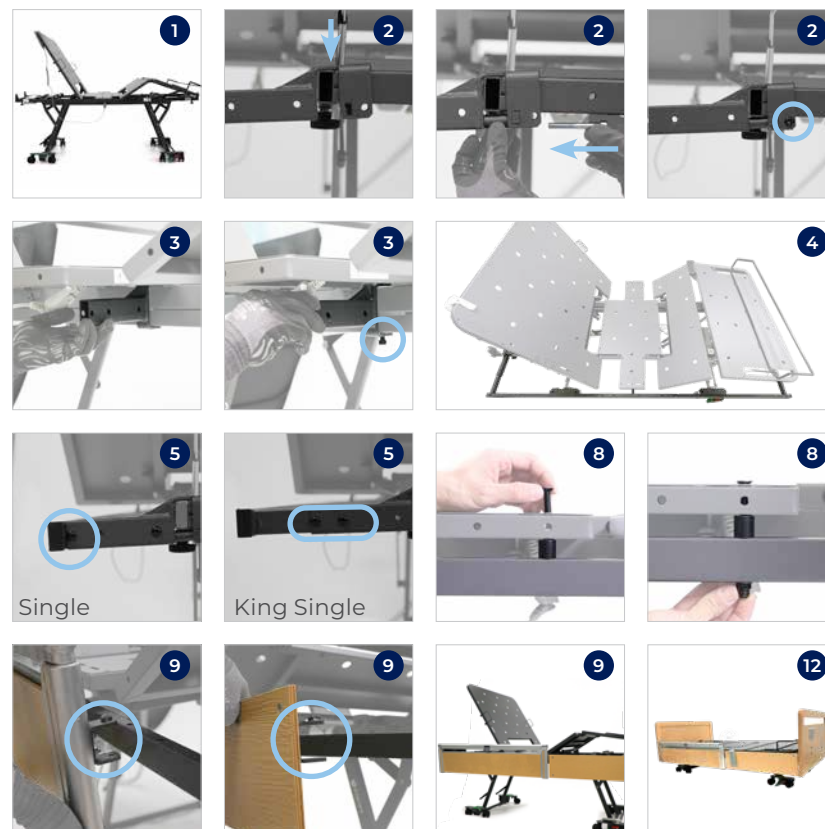

9.10 BATTERY BACK UP INSTALLATION



If fitted with a battery back-up unit the bed will automatically switch to battery power in the event of a power failure, or the bed being unplugged from mains power.

A fully powered new Battery Back-up may last 15 full lift cycles however this is dependent on user weight, movement range and battery age.

The FL250 Battery Back Up accessory is designed to provide back-up power in the event of a power outage or other event necessitating temporary use of the bed without access to a power outlet.

Carton Contents:

- 1 x Battery power pack with lead
- 1 x Bed attachment brackets for mounting to the bed
- Hardware (nuts and bolts)



Installation of FL250 Battery Back Up:

NOTE: BEB046590 is compatible with beds with serial number 'V1' ONLY
BEB046592 is compatible with beds with serial number 'V2' ONLY

1. For easy access to the bed chassis and control box, use the EasyMove Transport System to mount the bed and pivot vertically on its side.

2. Attach the battery backup to the bed and secure in place with the attachment bracket and included hardware. Note: if the beds' serial number includes 'V1' then the battery backup is mounted in the middle of the bed. If the beds' serial number includes 'V2' then the battery backup is mounted at the foot end of the bed.

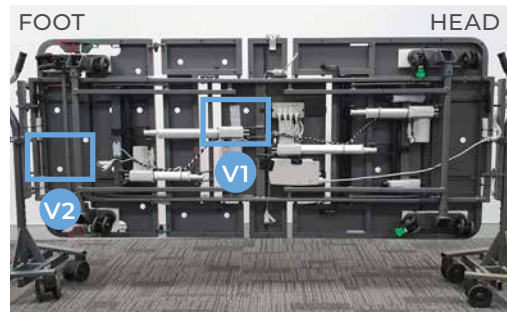

3. For beds with serial number 'V2' ONLY – attach the battery back up cable to the bed using zip ties, following the same path and zip tie locations as the attendant control panel cables all the way to the control box at the head end of the bed.
4. For beds with serial numbers 'V1' ONLY – remove the control box from the bed by undoing the control box brackets. All leads to the control box should remain attached.
5. On the top of the control box, locate and unclip the cover – exposing existing leads connected to ports and spare port.
6. Position the battery back up lead so the groove is aligned with the spare port and insert fully into port.
7. Reattach the control box cover.
8. For beds with serial number 'V1' ONLY – Reattach the control box to the bed.

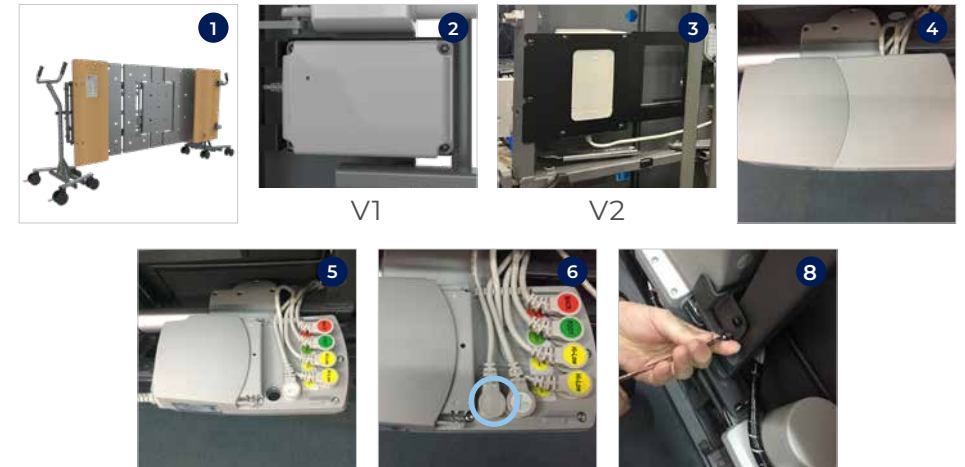

9.11 EASYMOVE TRANSPORT SYSTEM

The FL250 EasyMove Transport System is designed to facilitate safe and easy transport of an FL250 bed over longer distances or through tighter doors and passage ways. It also facilitates bend-free access for service and maintenance technicians.

Carton Contents:

- 2 x Base sections with 4 castors each
- 2 x Mid sections with quick release axle and pivoting bed attachment arms
- 2 x Handle sections
- Hardware (nuts and bolts)

Assembly of the EasyMove

1. Stand base section on its castors on a flat surface
2. Insert mid section into base section ensuring the shaft bend is pointing outwards (towards the outside and wider spaced base castors)
3. Insert nuts and bolts into either side of joining sections and tighten firmly
4. Insert the handle shaft into the mid section shaft, ensuring the handles are pointing up and inwards (towards the inside and narrower spaced base castors)
5. Insert nuts and bolts into either side of joining sections and tighten firmly

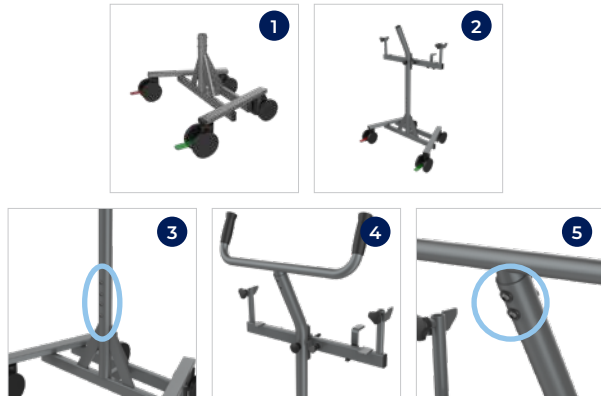

How To Use

Prepare the Bed for Mounting to the EasyMove Transport System

1. Remove all linen and mattress dressing from the bed
2. Position mattress platform to neutral (flat)
3. Disconnect ACP lead, remove head and foot boards from the bed frame and place on the mattress platform
4. Insert all bed extensions to the minimum length (foot and head end) and secure
5. Remove the wall buffer. Hang the hooked end over the EasyMove handle crossbar
6. Check wall buffer mounting barrels have securing springs in place so they cannot hang vertically. If not, attach securing springs or zip tie the barrels to the bed legs



Attach the Bed to the EasyMove Transport System:

7. Place an EasyMove trolley at either end of the bed. The narrower width base castors face in towards the bed
8. Position the pivoting bed attachment arms horizontally so the safety clip is to the right of the quick release axle
9. Lower the bed until the bed frame axle mount is level with the quick release axle on each EasyMove trolley
10. While pressing the quick release axle button push the EasyMove trolley gently forward, fully inserting the axle into the receiver
11. Ensure the alignment pin to the left of the axle inserts into the bed frame and safety clip to the right of axle is engaged – you will hear a click as it engages over the frame
12. Repeat for second trolley



Attach the Bed Head and Foot Board to the EasyMove Transport System

13. Hold the foot board horizontally so the bed end attachment pegs face down and the top of the foot board faces the centre of the bed
14. Lower the foot board inserting the attachment pegs into the horizontal mounting brackets
15. Fasten hand wheels to lock in place
16. Repeat for head board
17. If a Self Help Pole or IV Pole are present, these can remain attached to the bed head board but should be positioned to avoid impact with the mattress platform

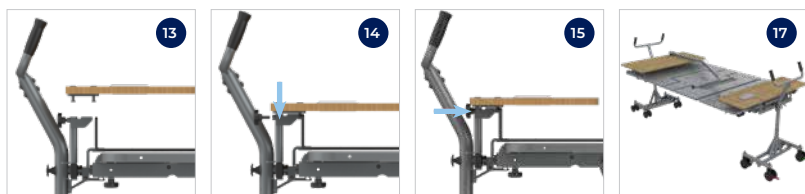

Lifting or Lowering the Bed Legs

18. Ensure there are no encumbrances on the bed legs
19. Press and hold the bed lower button on the handset
20. The bed legs will lift up to the bed frame
21. If the bed castors shift into a vertical position, stop the lift, adjust them manually to be parallel with bed frame, then continue the lift until bed legs are fully lifted into the bed frame – as if the bed was fully lowered in the flat position on the ground
22. Disconnect the mains power lead, gather and secure with Velcro
23. Repeat the above steps in reverse to lower the legs to the ground in preparation to remove the EasyMove Transport System



Pivoting the Bed Frame

24. Disengage the pivot lock on each EasyMove trolley by pulling and twisting
25. Gently pivot the bed on its axis by hand until vertical. This is a very easy motion requiring little force
26. If more than one hand is required there is likely to be an encumbrance on the pivot motion, please check around the bed
27. When the bed frame is vertical, re-engage the pivot locks by pulling and twisting
28. Repeat the above steps in reverse to reposition the bed surface horizontally in preparation for lowering



Moving the Bed with the EasyMove Transport System

29. The EasyMove Transport system can be manoeuvred by a single person, or two people
30. Ensure power, handset and any other leads are all secured and out of the way
31. If one person is moving the bed, engaging the directional locking castors on the forward of the two EasyMove trolleys will allow better control and manoeuvrability
32. If two people are moving the bed then using the directional castors is less necessary so they may remain disengaged
33. Using the trolley handles, push the trolley forward from the rear proceeding at an even pace

When the EasyMove Transport System is loaded but stationary or not in use, the total locking castors should remain locked at all times (red locking button).



9.12 USB PORT UPGRADE KIT

Carton Contents:

- | | | | |
|---|--------------------|---|----------------------------------|
| 1 | 1 x USB Port | 4 | 10 x Zip ties |
| 2 | 1 x Mounting strip | 5 | 2 x M4 x 16mm screws (not shown) |
| 3 | 1 x Splitter cable | 6 | 2 x M4 x 8mm screws |

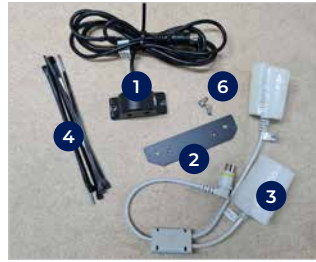

Assembly Instructions

NOTE: the USB port can be mounted to either the left or right side of the bed. The images in this manual are shown for assembly onto the right side of the bed.

1. Mount USB port to the mounting strip using the provided M4 x 8mm screws. (Only applicable to beds with serial number prior to FL250-V2-2204-24505)
2. Raise bed to comfortable working height and the backrest to maximum height
3. Remove the handwheels that secure the mattress retainer to the backrest but do not remove the mattress retainer. (Only applicable to beds with serial number prior to FL250-V2-2204-24505)
4. Assemble USB port to the underside of the backrest using the mattress retainer legs as studs and secure in place with handwheels (bed serial number prior to FL250-V2-2204-24505) or using the M4 x 16mm bolts (bed serial number after FL250-V2-2204-24505)

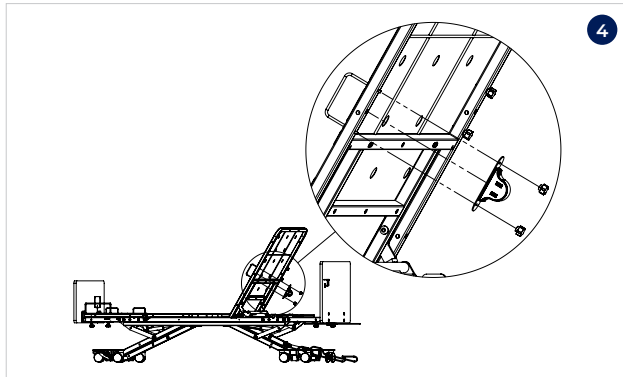
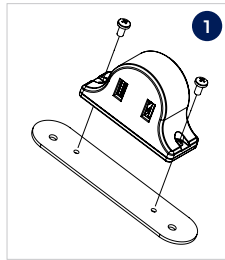

5. Secure the USB port cable to the backrest along the dashed path shown. Secure in place using the provided zip-ties which can be slipped in between the steel tubes and the sheet metal deck as anchoring points. Secure on the backrest and underneath the middle deck panel

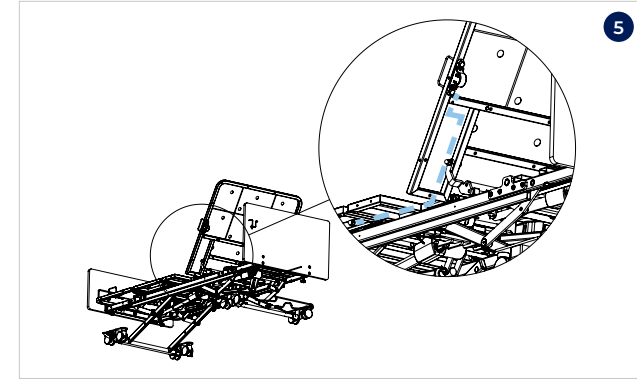

6. Once the cable is underneath the middle deck, slip it through the gap between the main structural tube and the deck panel (where the handset port cable runs through) and lead the cable towards the middle of the bed

NOTE: Image shown from front for clarity. Cable to be mounted on the underside of the backrest and mattress deck

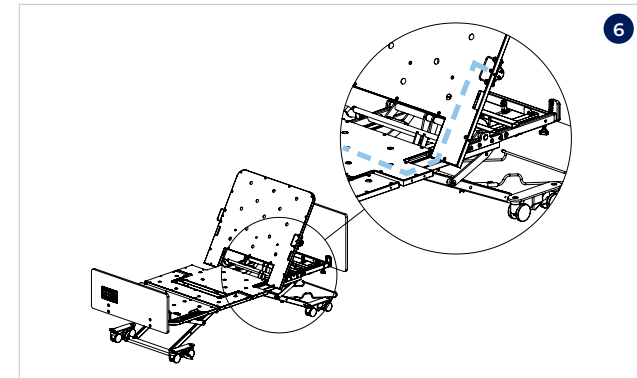

7. Lead the cable towards the remainder of the cables running towards the head side of the bed. Zip ties cable to the cables until it reaches the control box at the head end of bed. (Only applicable to beds with serial number after FL250-V2-2204-24505)
8. To connect the cord to the control box, remove the control box from the mounting bracket by removing the screw holding it in place and sliding control box out. (Only applicable to beds with serial number prior to FL250-V2-2204-24505)
9. Open control box and connect the splitter cable to the port shown

NOTE: battery backup (if installed) should be unplugged in order to connect the splitter cable. The battery backup is plugged into the splitter cable instead. (See next steps)

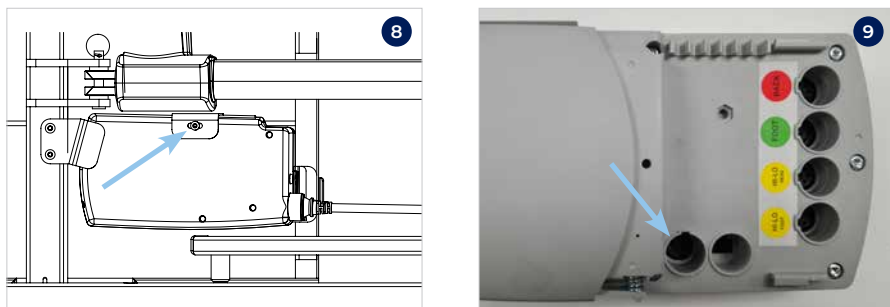

10. Close control box and reattach to bed
11. Attach the USB port cable to the splitter cable port marked 'TFA' and battery backup (if installed) to port marked 'TBB'
12. Test bed and USB port functions correctly. Ensure cables have enough slack to accommodate all deck panel movements
13. Ensure cables are secured in place and protected from any moving parts of the bed. Zip tie excess cable length to bed frame if required

Your USB upgrade kit installation is now complete.

10. GENERAL OPERATION

10.1 CASTOR SYSTEM – BRAKES & STEERING

10.1.1 Central Locking Castors

Central locking castors are located at the foot end of the bed. The brakes are interlinked on either side of the bed allowing operation with a single movement for improved safety and efficiency.

1. To engage the brakes push down on the red pedal as shown below until bed is locked in place
2. To disengage brakes push down on the green pedal until the brake system is completely unlocked

Pedal Positions

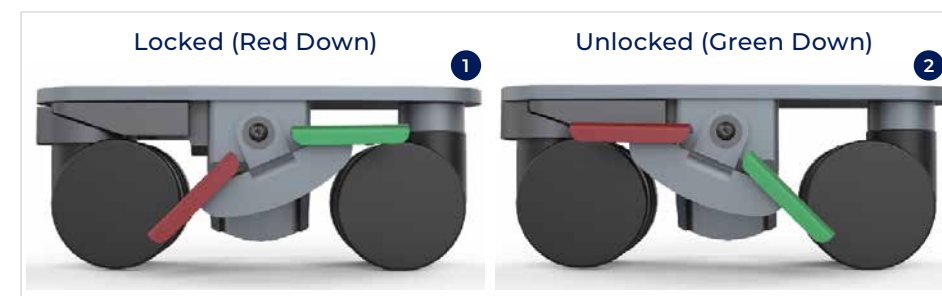

10.1.2 Directional Locking Castors

Directional locking castors are located at the head end of the bed

1. To engage the directional lock, ensure the green latch is pushed down and secured within the wheel
2. To disengage the directional lock, pull up on the green latch until unlocked



11. STORAGE & MOVEMENT

10.1.3 Moving the Bed at Lowest Height

Central Locking brake bar must be removed to disengage BrakeFirst function when bed is at lowest height.

1. To remove simply pull the sprung Red/Green brake lever out and the brake bar will disengage from its mounts
2. To reengage the bar, pull out the sprung Red/Green brake lever, position the brake bar end and release the lever and it will lock in place

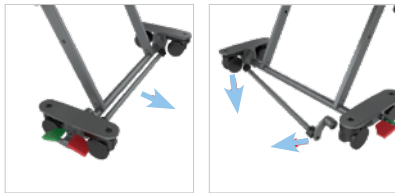

10.2 Bed Extension

The integrated bed extension can add 100mm / 4" or 210mm / 7.9" of length to the mattress platform.

Moving Bed Extension From Closed/Standard Bed Position

1. The bed extension locates with an indexed adjustment mechanism and can be tightened in position with hand wheel bolts
2. Unscrew the hand wheel bolts, slot mattress retainer into desired position
3. Tighten the hand wheel bolts



The bed extension is designed for use as a bed extension only and is not meant to support the body weight of a person sitting. The extra length of the bed with extra load can also make the bed unstable potentially resulting in injury to the user and patient



- Disconnect the bed power cord before moving the bed
- Do not remove the power cord from the source by pulling on the cord
- Do not pull on the power cord, or handset cord to manoeuvre the bed
- Always apply the brakes when the bed is in a stationary position

Handle With Care

FL250 Beds should be stored in a clean, dry, well ventilated area.

Do not drop and avoid shock or violent impact when transporting.

The following limits apply during transport and or a storage period of up to 15 weeks duration:

Ambient temperature	-25°C – 70°C
Relative humidity	10% – 75%
Air pressure	50 kPa – 106 kPa

The following limits apply to normal operating conditions and or periods of storage longer than 15 weeks:

Ambient temperature	+10°C – 40°C
Relative humidity	30% – 75%
Air pressure	70 kPa – 106 kPa

Moving your FL250 Bed

1. Before moving the bed, press the **ExitSafe** position button on the handset or ACP until it is in position
2. Release the brakes using the green pedal



3. Ensure handset is stored safely in the holder on the rear side of the head board
4. Unplug the mains cable from the wall socket, coil up and place under the mattress (if not mattress in place hang over mattress retainer)
5. Activate directional castor on head end of the bed to assist with pushing in a straight line down hall ways

12. CLEANING



WARNING

Before cleaning always disconnect the bed from the mains power source

NOTE: It is strongly recommended that protective clothing be used when cleaning.

NOTE: For easy access to all parts of the bed and for safe handling, use the EasyMove Transport System.

NOTE: The following procedure also applies to bed accessories, but does not include mattresses.

- Wipe the bed's surfaces with a soft cloth moistened with hot water and mild detergent (or the facilities recommended cleaning solution). It is recommended that the cloth be a white material to prevent bleeding of dye colours to the bed. Take extra care in areas that may harbour dirt or dust
- Rinse with clean water and dry with a clean cloth
- To remove potentially infectious materials such as body fluids, or when the bed has been used by someone with a known infection. Clean with NaDCC (e.g. Presept, Actichlor) at 10,000 ppm of available chlorine. Rinse and dry
- Allow the cleaned parts to dry before replacing the mattress



WARNING

Do not use abrasive Hypocarbonate or Phenolic compounds or pads

13. MAINTENANCE

To prolong the working life of the bed and for trouble free operation it is recommended that routine inspections should be performed by a person who is suitably qualified and well acquainted with the design, use and care of your FL250 Bed.

If inspection reveals that the safety of the bed is jeopardised in any way, it should be IMMEDIATELY WITHDRAWN FROM SERVICE, tagged as such and the owner notified.

NOTE: Other than general maintenance activities all other service or repair work must be performed by qualified and trained persons who are approved by Aidacare.

NOTE: For easy access to all parts of the bed and for safe handling, use the EasyMove Transport System.



WARNING

The bed must be disconnected from the mains power supply before starting any maintenance activity

General

- 1 Examine all the warning signs on the bed, examine the bed for obvious signs of damage. All aspects of the equipment should operate as intended. Check that all nuts, bolts and other fasteners are tight and are not missing
- 2 Examine flexible cables and conduits for cuts, cracks, abrasions or other deterioration
- 3 Check that the power supply plug is not damaged. If either the power cable or plug is damaged then both the cable and plug must be replaced as a complete assembly by an approved service agent

Brake System

- 1 Activate brakes in the locked position and apply pressure to the bed foot end.
- 2 If the bed castors rotate the brakes should be adjusted accordingly
- 3 If the bed does not stay stationary the bed should be removed from service until the issues are rectified

Battery Backup

- 1 Check battery indicator light on attendant control panel to monitor condition of battery back-up

14. TROUBLESHOOTING

IMPORTANT!

Prior to making any adjustments to the electronics of the bed, the control box should always be reset to rule out any calibration issues.

Calibration issues can occur when power outages happen or when beds are unplugged from the wall during use.

To complete a reset

1. Hold down the top two buttons of the handset (Top Left + Top Right)
2. After 5 seconds continue to hold and the bed will enter reset sequence
This will result in all actuators retracting to their minimum length which manifests as the bed flattening and descending to the lowest position
3. Once the bed reaches this position a faint relay 'click' can be heard and the handset LED light will flash several times indicating reset procedure is complete
4. If the bed does not perform normally after being reset, please explore the trouble shooting guide suggestions

Effect	Possible Cause	Verification	Corrective Action
Bed does not stay in place	Braking system is not in Total Brake position Brake System is malfunctioning	Brake pedal is not engaged in lowest position Brake pedal is in lowest position, but bed does not stay in place	Brake pedal is not engaged in lowest position Contact your sales representative or a qualified Aidacare service technician
Bed does not move up or down	Bed is not plugged in and optional battery is flat Actuator is faulty Handset is faulty NCP is Faulty	Check if the power lead is plugged into mains power Swap handsets, actuator & NCP	If unplugged, plug power leads into mains power. Allow 3 hours to charge battery (if fitted) Conduct electronic system reset - refer to section 6.4 Contact your sales representative or a qualified Aidacare service technician
Backrest does not move up or down	Actuator code is unplugged Actuator is faulty Handset is faulty NCP is Faulty	Check if cables have come loose from control box (under top frame at head end) Swap handsets, actuator & NCP	If loose, fully plug cables into control box Conduct electronic system reset - refer to section 6.4 Contact your sales representative or a qualified Aidacare service technician

15. WARRANTY & SERVICE

Aidacare FL250 Beds carry a comprehensive warranty as detailed below. Please keep proof of purchase for proof of warranty commencement.

10 YEARS WARRANTY
Frame

3 YEARS WARRANTY
Electronics

1 YEARS WARRANTY
Handsets & Cable

Consumer Warranty Against Defects

Aidacare is bound by Australian Consumer Law in respect to Warranty Against Defects. A copy of the Aidacare Warranty Against Defects statement is available on the **Aidacare homepage** at **aidacare.com.au**. All warranty matters should be directed to **Aidacare Customer Service** on **1300 133 120**.

Aidacare does not warrant against excessive or incorrect use, modification or any situation that could not be deemed as fair wear and tear. This is a back to base warranty and does not cover freight costs pertaining to the return of any items under warranty. Aidacare acknowledges and conforms to all ACCC guidelines around consumer rights. For further information contact **Aidacare** on **1300 133 120** or email **product@aidacare.com.au**.

Aidacare will not warrant the safety and or correct functioning of products where any original components have been changed or modified by non-Aidacare approved and trained service & maintenance staff or external providers. Furthermore, safety is not guaranteed where components have been replaced with non-original Aidacare approved parts. If any faults are detected upon receipt of this product please phone Aidacare. Any faults that are detected during normal use should be reported to Aidacare immediately to determine if warranty conditions apply and if so, the necessary repair or replacement work to be completed.

Spare parts list is available upon request.

For servicing, preventative maintenance and any other questions regarding this or any other Aidacare product please contact:

AIDACARE PTY LTD

Building 3A, 1 Moorebank Avenue,
Moorebank NSW 2170
Australia

1300 133 120 | aidacare.com.au

AIDACARE LIMITED

Arcadia House, Maritime Walk,
Ocean Village, Southampton SO14 3TL
United Kingdom

01622 541235 | aidacare.co.uk

16. SERVICE LOG BOOK

Year 1	Date: _____
Service Type: _____	
Condition Report: _____	
Inspected by: _____	Signature: _____
Action taken: _____	Date: _____

Year 2	Date: _____
Service Type: _____	
Condition Report: _____	
Inspected by: _____	Signature: _____
Action taken: _____	Date: _____

Year 3	Date: _____
Service Type: _____	
Condition Report: _____	
Inspected by: _____	Signature: _____
Action taken: _____	Date: _____

Year 4	Date: _____
Service Type: _____	
Condition Report: _____	
Inspected by: _____	Signature: _____
Action taken: _____	Date: _____

Year 5	Date: _____
Service Type: _____	
Condition Report: _____	
Inspected by: _____	Signature: _____
Action taken: _____	Date: _____

AIDACARE PTY LTD

Building 3A, 1 Moorebank Avenue,
Moorebank NSW 2170
Australia

1300 133 120 | aidacare.com.au

AIDACARE LIMITED

Arcadia House, Maritime Walk,
Ocean Village, Southampton SO14 3TL
United Kingdom

01622 541235 | aidacare.co.uk

MADE IN PRC