

s o v a / dignity in motion







Dedicated design. Seamless movement. Pride in our products.



Exclusively distributed by

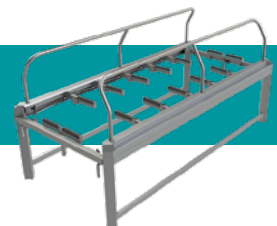

## Product Range

	<b>300 Series Storage System</b>	<b>3</b>
	<b>500 Series Storage System</b>	<b>9</b>
	<b>Trolleys</b>	<b>14</b>
	<b>Manual Handling</b>	<b>17</b>
	<b>Cemetery</b>	<b>18</b>
	<b>Custom</b>	<b>20</b>

## 300 series storage system

### Features

- Ideal for small to medium funeral homes
- Stainless steel flat pack construction
- Zinc treated ball bearing rollers
- Fits cadaver trays, coffins and caskets
- Front retainer bracket
- Rubber bumpers at end stop
- Manual or electric trolley drive options



Front retainer bracket



550mm ball bearing rollers



Side loading option

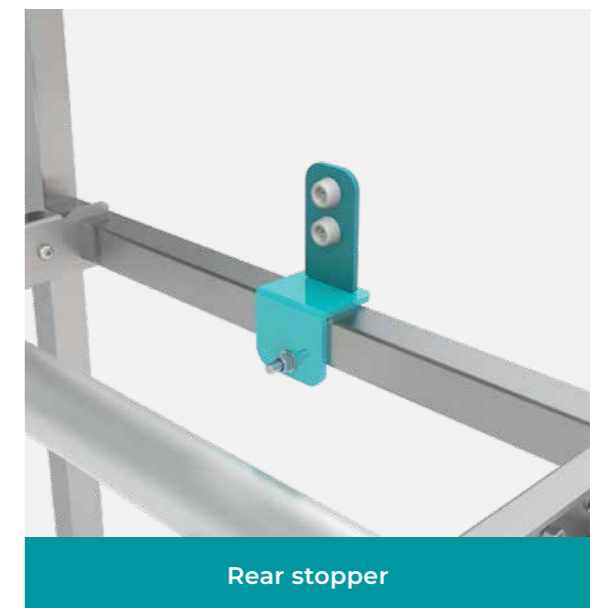

Rear stopper

## Mortuary Trolley - 300kg 4H803

300 Compatible

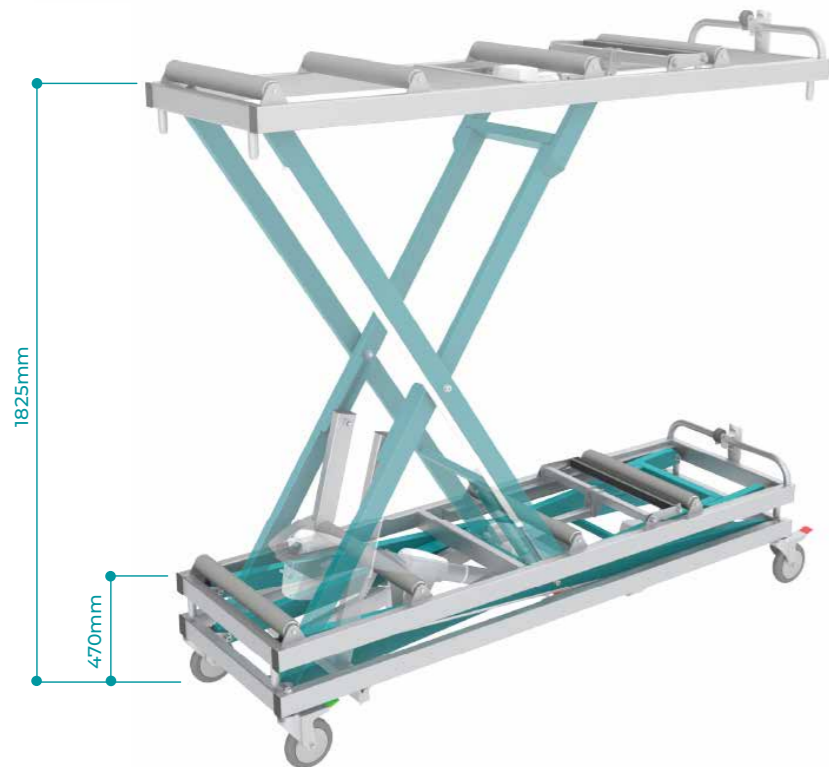
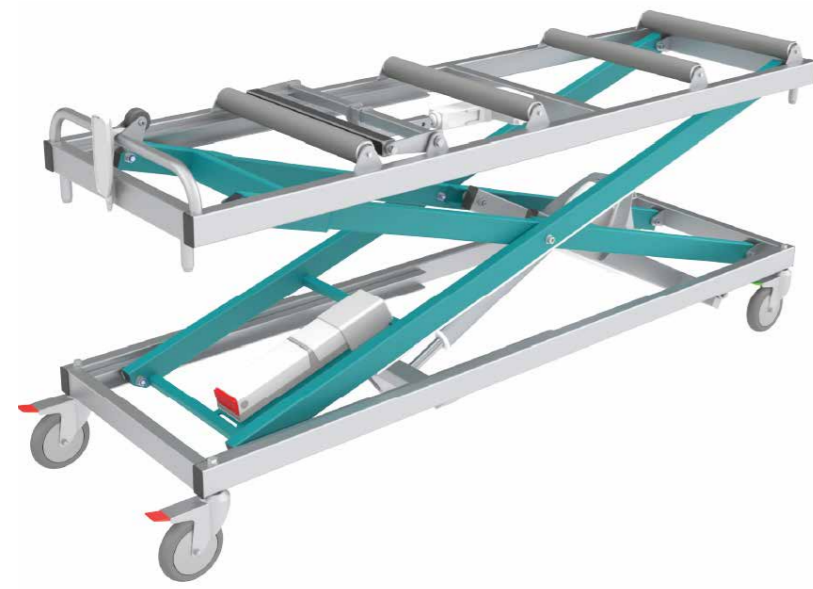

- 300kg SWL
- Handset high/low operation
- Heavy duty ball bearing rollers
- Epoxy powder coated frame
- Height adjustable push handle
- Electric high/low operation
- Removable rechargeable lithium battery pack
- Electric Body tray and Coffin Brake
- Electric Body Tray drain angle function
- 150mm lockable castors
- 2105mm long with body tray - 1:10 ramp compatible
- Concealment width 780mm
- Only Compatible with 300 series systems

### Options

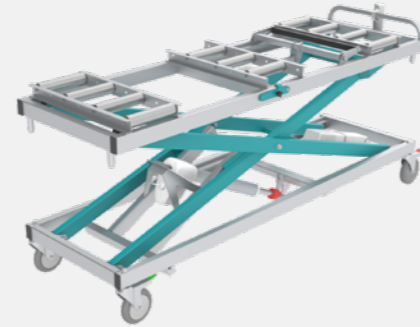

Side loading (4H803SL)

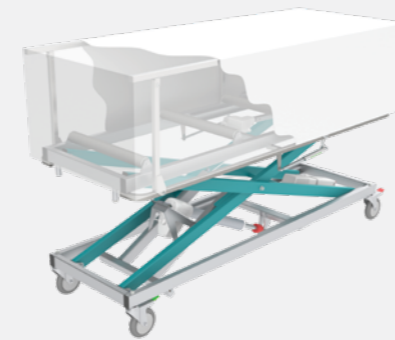

Concealment Top (C)

- 4H803 - End Loading
- 4H803C - End Loading Concealment
- 4H803SL - Side Loading
- 4H803SLC - Side Loading Concealment

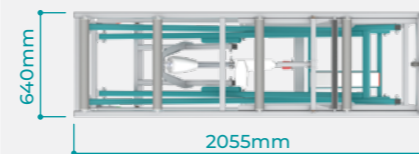

## Mortuary Trolley - 300kg 4H803DU

300 Compatible

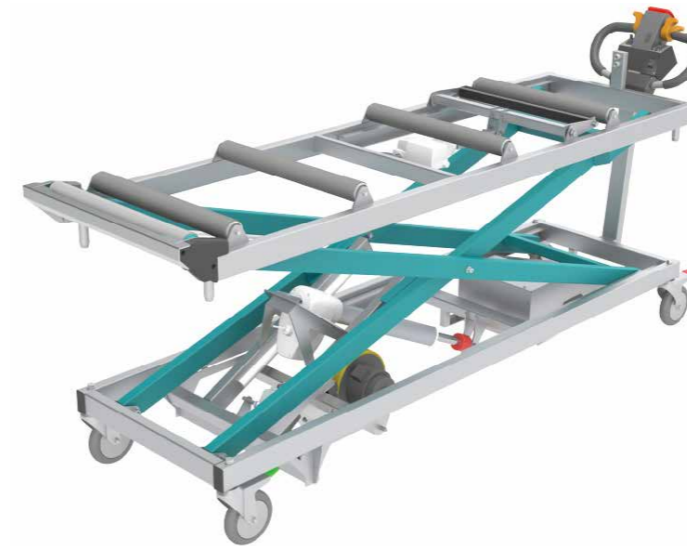

- 300kg SWL
- Rubber coated rollers Handset high/low operation
- Heavy duty ball bearing rollers
- Epoxy powder coated frame
- Height adjustable push handle
- Electric high/low operation
- Removable rechargeable battery pack
- Electric Body tray and Coffin Brake
- Electric Body Tray drain angle function
- 150mm lockable castors
- 2105mm long with body tray
- Variable speed drive unit
- Retractable drive wheel
- 2320mm length without Tray Drive Roller
- Concealment width 780mm
- Only Compatible with 300 series systems

### Options

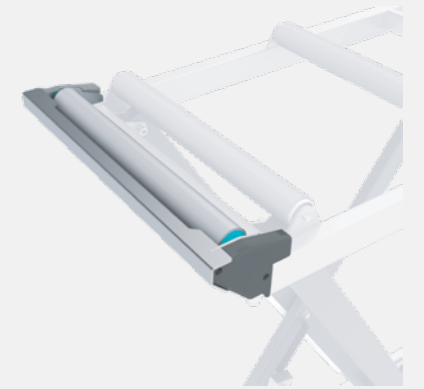

Tray Drive Roller (T)



Concealment Top (C)

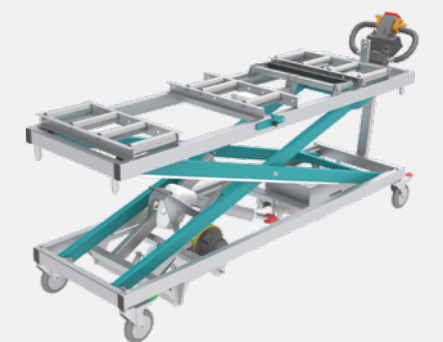

Side Loading (SL)

- 4H803DU - End Loading
- 4H803DUC - End Loading Concealment
- 4H803DUSL - Side Loading
- 4H803DUSLC - Side Loading Concealment
- 4H803DUT - End Loading, Tray Roller
- 4H803DUCT - End Loading Concealment, Tray Roller

## Mortuary Racking 4H823 and 4H824

300 Compatible

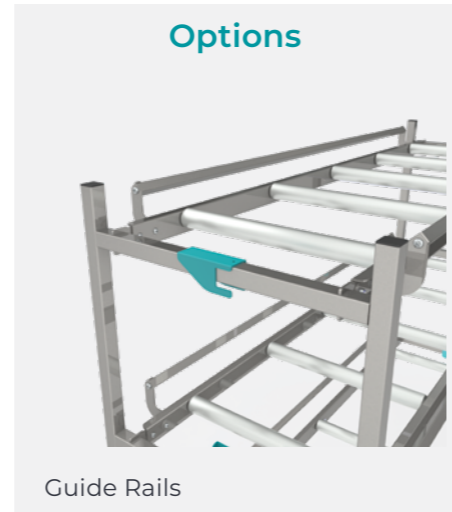

- Stainless Steel flat pack construction
- Zinc treated ball bearing rollers
- Adjustable leveling feet
- Fits cadaver trays, coffins and caskets
- 5 full width rollers per tier
- Front retainer bracket
- Rubber bumpers at end stop
- Max weight up to 300kg\*
- Only Compatible with 300 series systems
- Compatible with 4H809 cadaver trays only

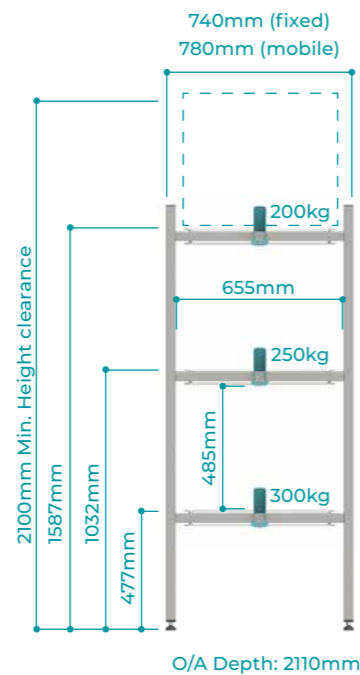

4H823 / 4H823M  
(Mobile)

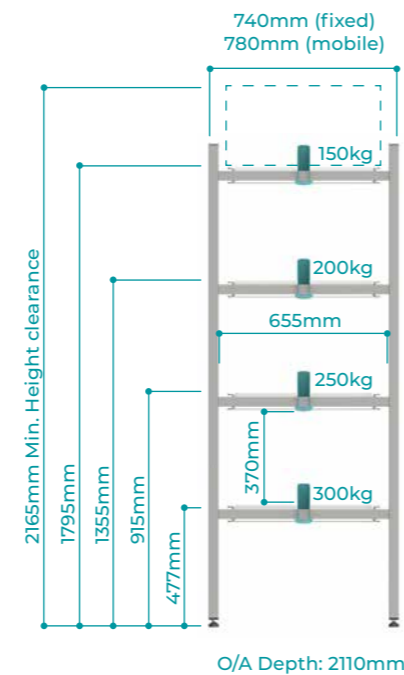

4H824 / 4H824M  
(Mobile)

## Side Loading 4H823SL and 4H824SL

300 Compatible

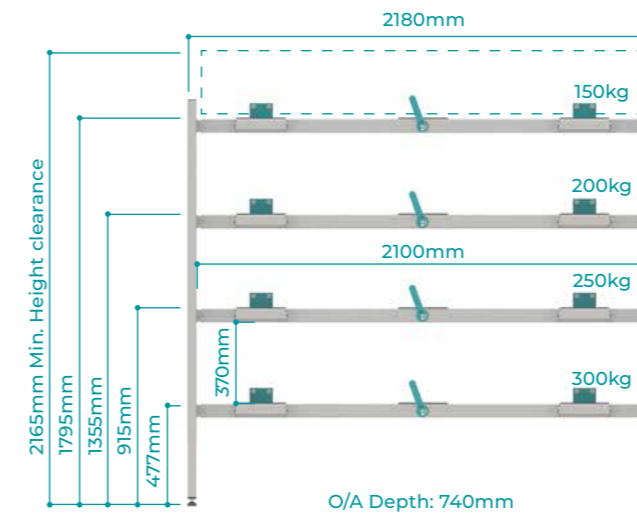

4H824SL

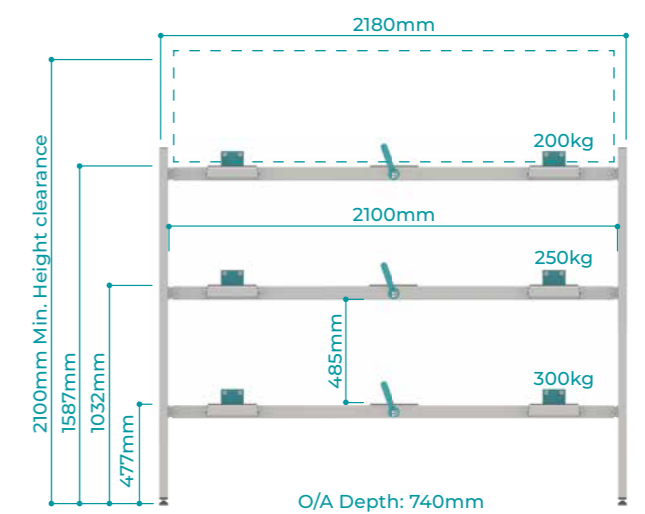

4H823SL

- Stainless Steel flat pack construction
- Zinc treated ball bearing rollers
- Adjustable leveling feet
- Fits cadaver trays, coffins and caskets
- 5 full width rollers per tier
- Front retainer bracket
- Rubber bumpers at end stop
- Max weight up to 300kg\*
- Only Compatible with 300 series systems
- Compatible with 4H809 cadaver trays only

## Cadaver Tray 4H809

300 Compatible

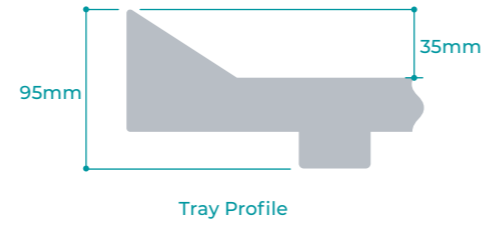

- 300kg SWL
- 304 stainless steel construction
- Push/pull handle
- Angled sides allow for easy side transfer
- Sub-frame for strength
- Angled corners allow for easy cleaning and fluid removal
- Fully welded stainless steel top with impeccable finish

## Cadaver Tray - Side Loading 4H809SL

300 Compatible

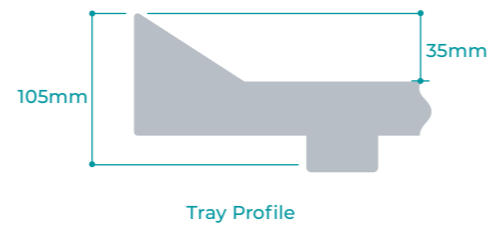

- 300kg SWL
- 304 stainless steel construction
- Push/pull handle
- Angled sides allow for easy side transfer
- Sub-frame for strength
- Angled corners allow for easy cleaning and fluid removal
- Fully welded stainless steel top with impeccable finish

## 500 series storage system

### Features

- Ideal for medium to large mortuaries
- Stainless steel flat pack construction
- Full width zinc treated ball bearing rollers
- Fits cadaver trays, coffins and caskets
- Rubber bumpers at end stop
- Built in side bumpers
- 350kg and 500kg capacity



Built in side bumpers



Full width ball bearing rollers



Easy access for drive roller



Full width rear stopper

## Modular Coffin Storage System 4H828

500 Compatible



ADD  
REMOVE  
CONFIGURE



900mm - 1 bay bariatric  
1500mm - 2 bay bariatric  
1800mm - 2 bay bariatric  
2100mm - 3 bay bariatric  
2400mm - 3 bay large bariatric

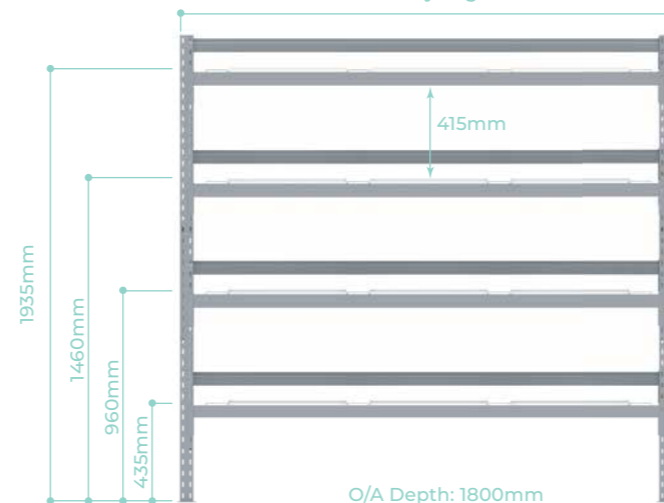

O/A Depth: 1800mm

900mm - 1 bay bariatric  
1500mm - 2 bay bariatric  
1800mm - 2 bay bariatric  
2100mm - 3 bay bariatric  
2400mm - 3 bay large bariatric

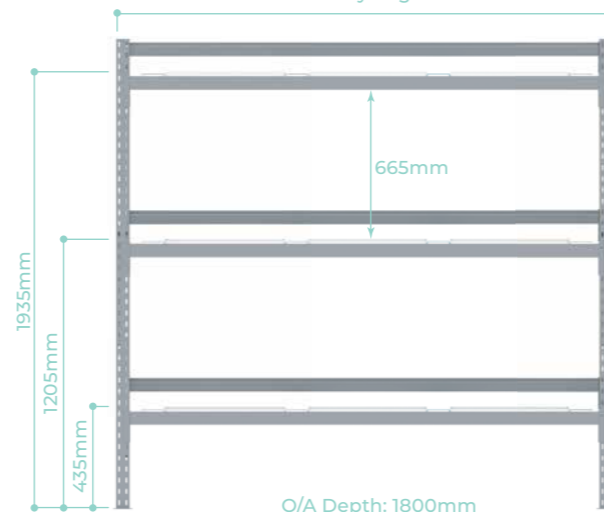

O/A Depth: 1800mm

### Flexibility - Oversized coffin across 2 bays

- 350kg - 200kg SWL depending on configuration
- Universal racking for coffins
- Customisable layouts and tier openings
- Multi width tiers to allow oversized coffins
- Powdercoated mild steel construction
- Zinc plated ball bearing rollers
- Rear stopper
- Compatible with 300 and 500 series systems

## Mortuary Trolley - 500kg 4H801DU

500 Compatible

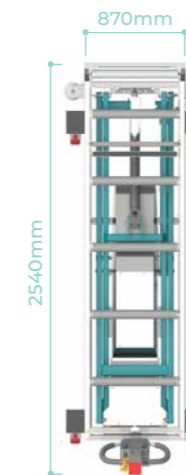
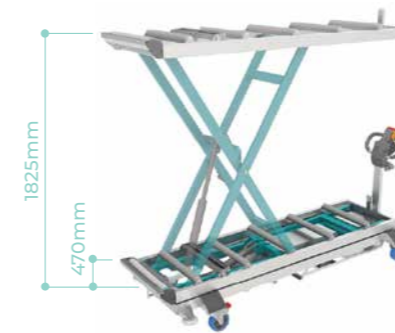
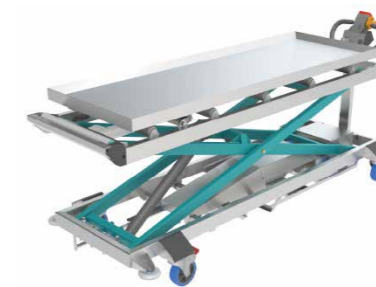
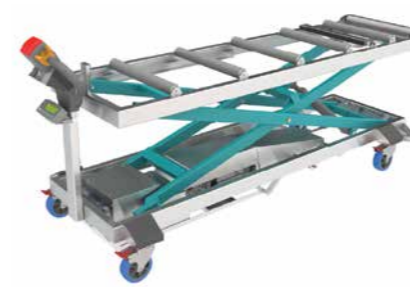

- 500kg SWL
- Variable speed Electric over hydraulic high/low operation
- Dual purpose roller design for coffin and body trays
- Heavy duty ball bearing rollers
- Stainless steel top and bottom frame
- Epoxy powder coated frame
- Electric coffin/tray brake
- 150mm lockable castors
- Variable speed drive unit
- Retractable drive wheel
- 2425mm long without Tray Drive Roller Only Compatible with 500 series systems
- Compatible with all SOVA cadaver trays

### Options

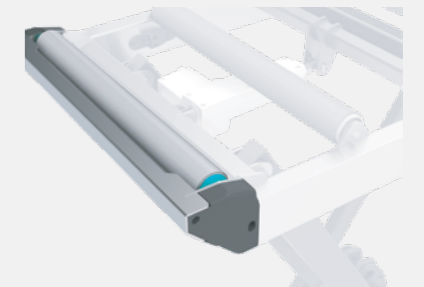

Tray Drive Roller (T)

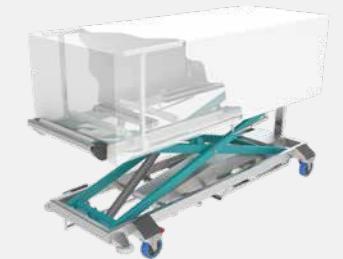

Concealment Top (C)



Weigh Scale (W)

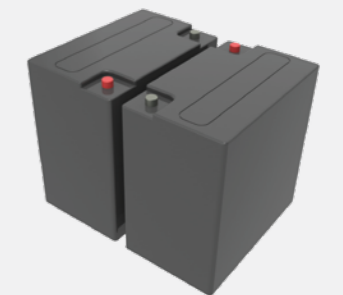

Deep Cycle Batteries (DB)

4H801DU - Drive Unit  
4H801DUT - Tray Roller  
4H801DUW - Weigh Scale  
4H801DUTW - Tray Roller and Weigh Scale  
4H801DUC - Concealment  
4H801DUCW - Concealment and Weigh Scale  
4H801DUTC - Tray Roller and Concealment  
4H801DUTCW - Tray Roller, Concealment and Weigh Scale

## Racking 4H823XBP

500 Compatible



- Stainless Steel flat pack construction
- Zinc treated ball bearing rollers
- Adjustable leveling feet
- Fits cadaver trays, coffins and caskets
- 5 full width rollers per tier
- Rubber bumpers at end stop

- Max weight 500kg 3 tier and 350kg 4 tier
- Built in side rails
- 3 or 4 tier rack options
- Only Compatible with 500 series systems
- Compatible with all SOVA cadaver trays

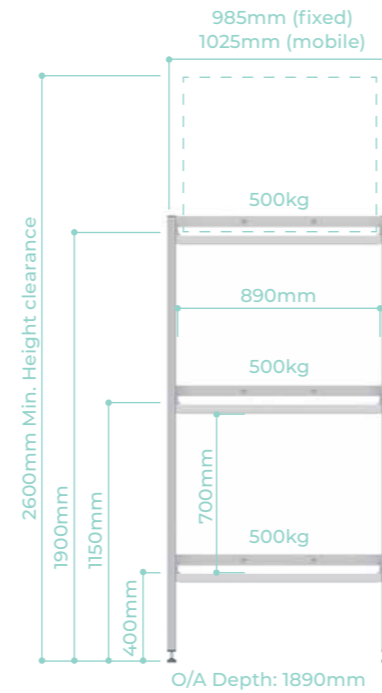

## Cadaver Tray 4H823XBP and 4H811PD

500 Compatible

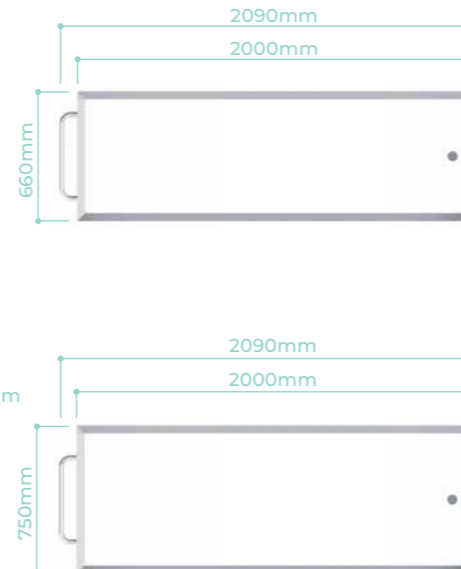
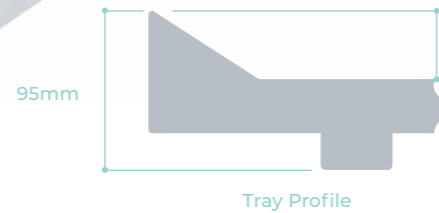

- 304 stainless steel construction
- Push pull handles
- Angled sides allow for easy side transfer
- Sub-frame for guided transferring
- Angled corners allow for easy cleaning and fluid removal
- Fully welded stainless steel top with impeccable finish
- Optional drain hole with plug
- Only Compatible with 500 series systems

## Racking - 3 and 4 Tier Systems 4H823P and 4H824P

500 Compatible

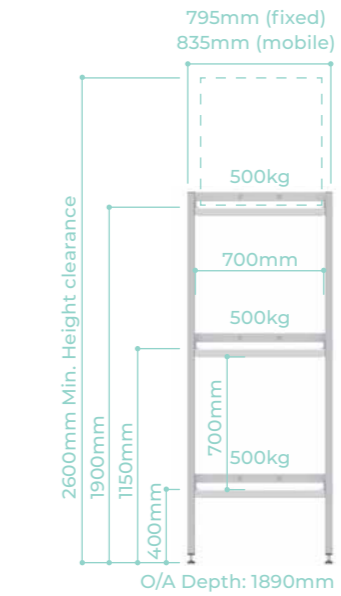

4H823P / 4H823PM (Mobile)

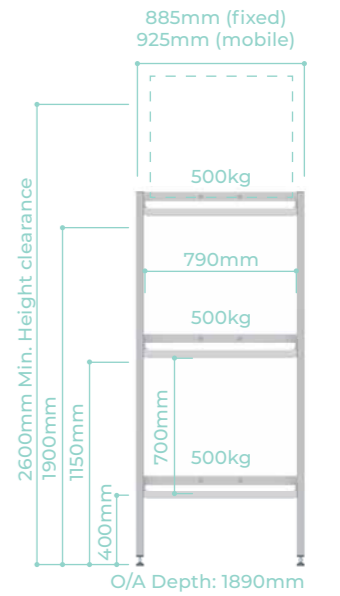

4H823BP / 4H823BPM (Mobile)

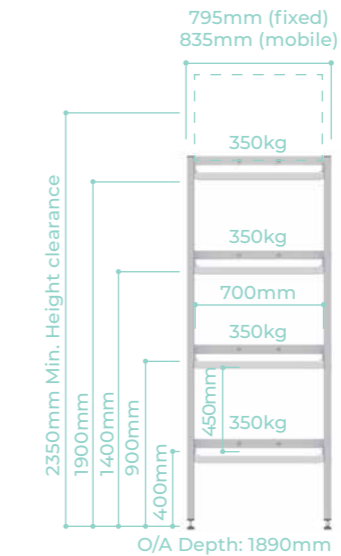

4H824P / 4H824PM (Mobile)

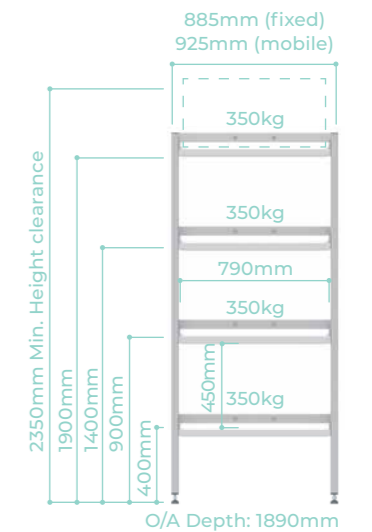

4H824BP / 4H824BPM (Mobile)

- Stainless Steel flat pack construction
- Zinc treated ball bearing rollers
- Adjustable leveling feet
- Fits cadaver trays, coffins and caskets
- 5 full width rollers per tier
- Rubber bumpers at end stop

- Max weight 500kg 3 tier and 350kg 4 tier
- Built in side rails
- 3 or 4 tier rack options
- Only Compatible with 500 series systems
- Compatible with all SOVA cadaver trays

## Chapel Trolley 4H860 and 4H862

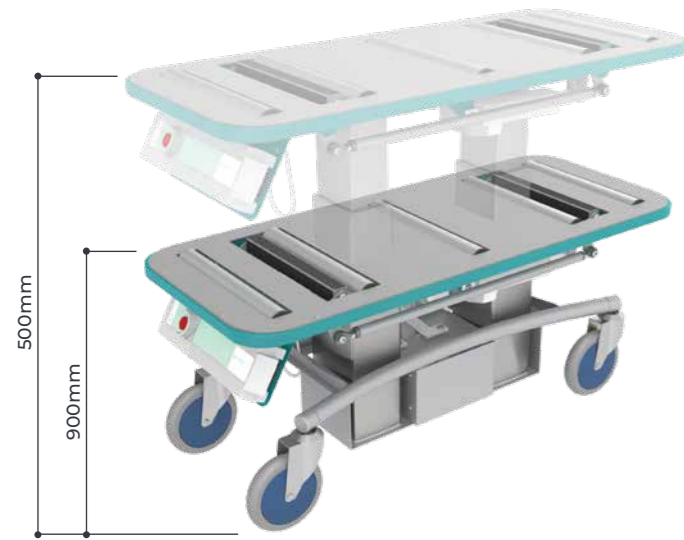

4H860



4H862

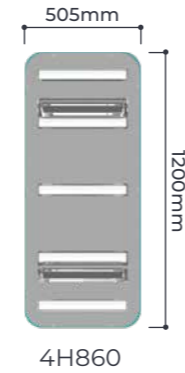

4H860

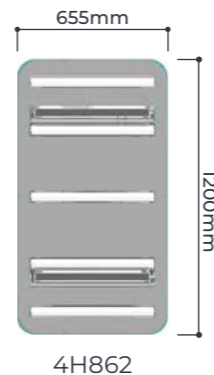

4H862

- 350kg load capacity
- Linak electrics – 24 volt system
- Wireless and hard-wired handset
- Removable Battery
- Zinc epoxy coated framework
- Dia200 castors

- Duel floor locks
- Electric casket lock
- Durable PVC top
- Roller Bearings
- Optional fabric skirt 4H860S



## Mortuary Concealment Trolley Fixed Height 4H840



- 200kg SWL
- 304 stainless steel top section
- Epoxy powder coated base frame
- 125mm lockable castors
- Push handles both ends
- 660mm wide tray



## Chapel Trolley Fixed Height 4H842

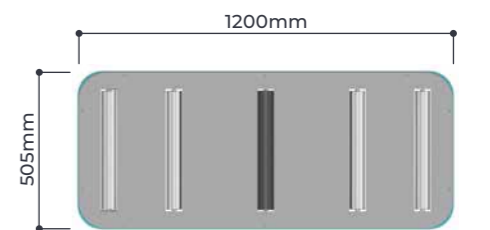

- 200kg SWL
- 304 stainless steel top section
- Epoxy powder coated base frame
- 125mm lockable castors
- Push handles both ends





## Autopsy Table - Mobile 4H805

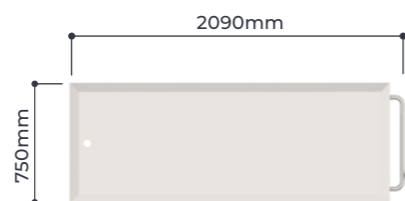

- 300kg SWL
- Dual actuators
- 304 stainless steel top section
- Epoxy powder coated base frame
- Electric high/low operation
- Rechargeable battery pack
- 125mm lockable castors
- Concealment width 830mm with 660mm wide tray
- Drain hole
- Electric tilt function for easy drainage
- Ergonomic base design
- Zinc pre-treated epoxy powder coated base
- Wired handset
- Custom widths available
- Push handle

**Accessories**

Perforated Sheet (4H805PS)

**Options**

Concealment (4H805C)

## Ceiling Track Hoist 4H837

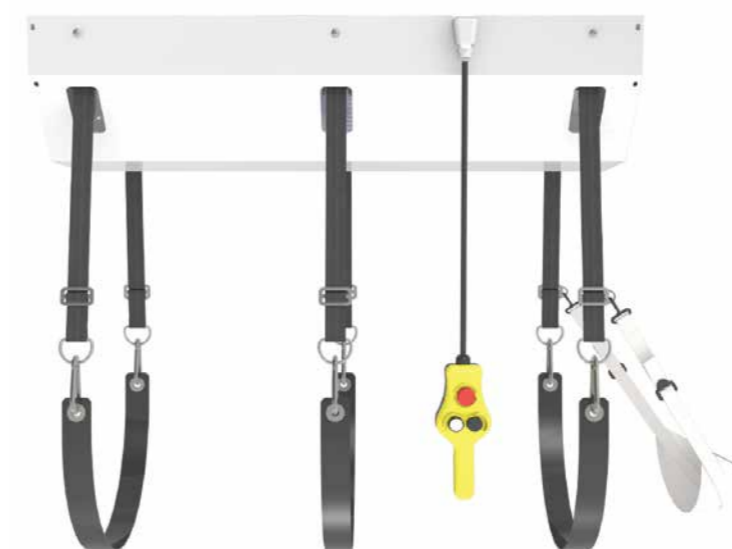

- 500kg SWL
- Two speed Electric motor for high/low operation
- H- (body) 300mm W- 1200mm D- 470mm
- Lifting range - 3000mm Max.
- Ceiling track rail to be quoted separately - POA

**Options**

270° Pivot Trolley

Cable Management System

Weigh Scale

**Accessories**

Lifting Strap - (4H837S)

Head Support - (4H837H)

**4H837C** - Body Lifter and Cable Management  
**4H837CT** - Body Lifter, Cable Management and 270° Pivot Trolley  
**4H837CW** - Body Lifter, Cable Management Weigh Scale  
**4H837CTW** - Body Lifter, Cable Management, 270° Pivot Trolley and Weigh Scale

## Mortuary Spreader Bar 4H832



- 360 kg SWL
- Multiple hook positions- 13 in total
- Simple and fast attachment
- Epoxy powder coat finish
- Central hanging pivot point
- Mild steel heavy wall tubular frame
- Suitable for use with ceiling mounted lift systems and floor hoists

## Cemetery

## Casket Lowering System



### A revolutionary funeral experience

- Retractable loading rollers
- Safety Guard Rails
- Unique lowering strap configuration for more controlled coffin lowering
- Coffin end stops
- Heavy duty engineered polymer rollers
- Epoxy powder coated steel frame
- Knock down construction for storage
- Lever action swing away support rollers
- Heavy duty construction

Paying respects

Internment

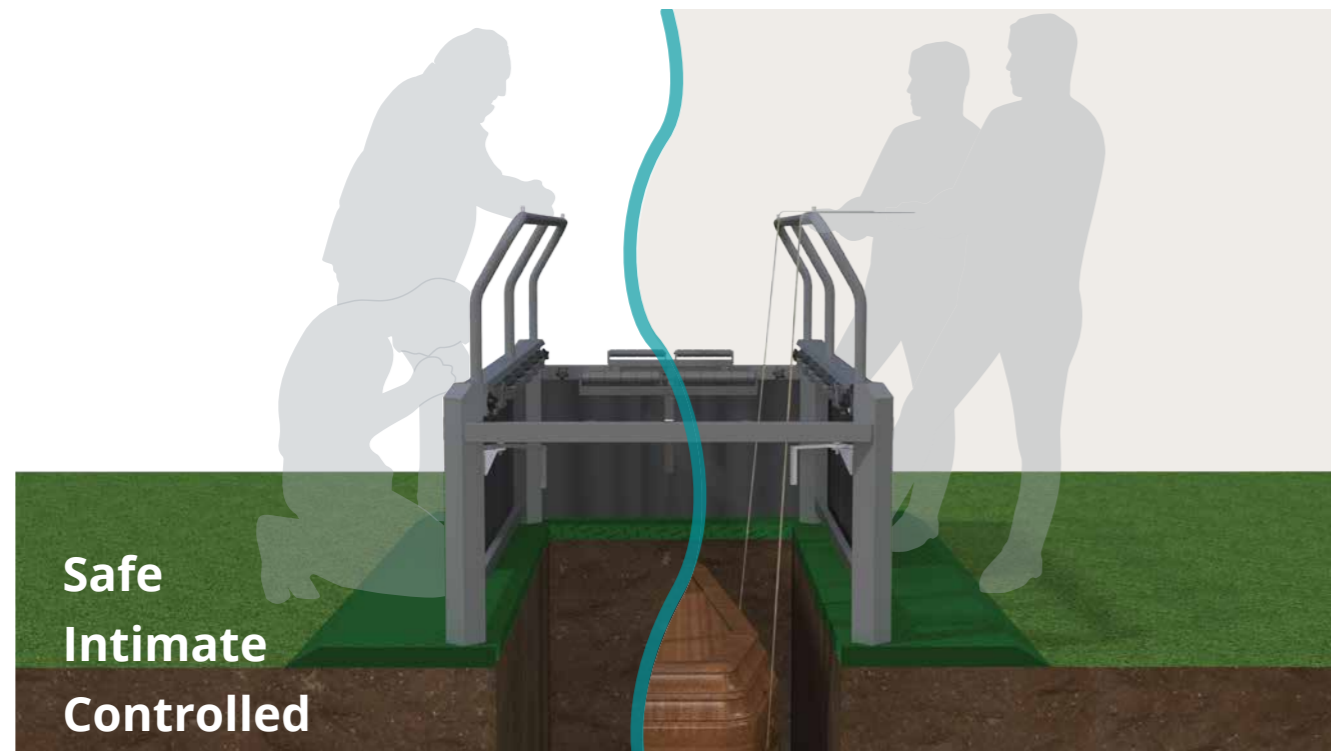

**Safe  
Intimate  
Controlled**

### Options



**Casket Lowering Device (4H890)**  
Stand alone unit or used in conjunction with the grave surround and covers to create a seamless system

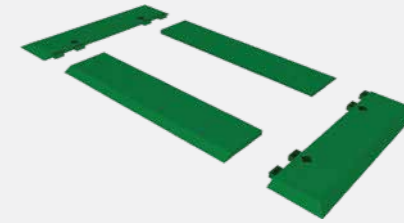

**Grave Surround (4H891)**  
• Light weight aluminum surround to prevent cave-ins  
• Stable walkable nonslip surface



**Trailer (4H895)**  
• Convenient way to store and transport the Coffin Lowering System

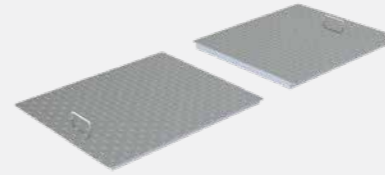

**Grave Surround (4H893)**  
• Covers to safely guard the grave site in preparation for the burial  
• Lightweight aluminum  
• Can be removed after lowering system is in place



**Skirt (4H890S)**

### Grave Spreader 4H892

- Epoxy powder coated
- Adjustable width settings

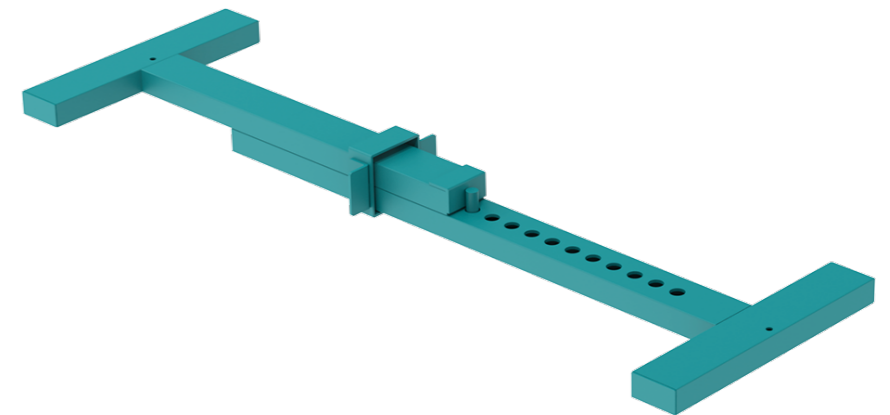

## Custom Equipment



Custom Bench and Sinks



Downdraft Embalming Table



Custom Chapel Trolley



Flower Trolley

## Custom Solutions

Contact us for your custom layout optimisation and design solutions

Typical layout  
Capacity = 54

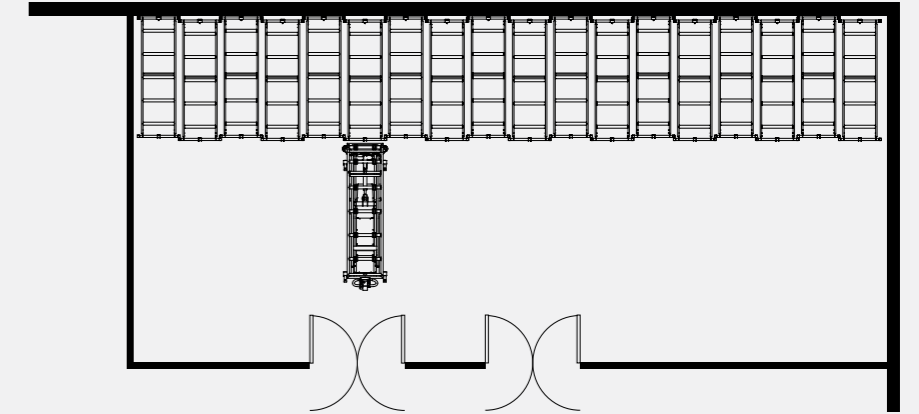

Optimised layout  
Capacity = 66

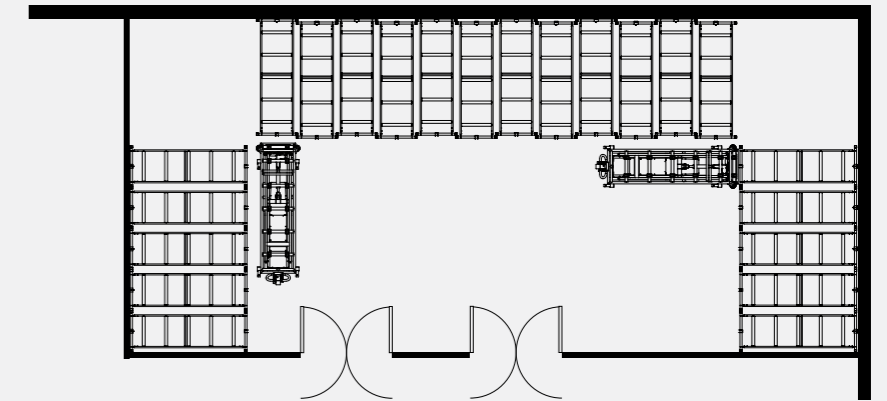

Custom Designed Solutions  
Helicopter transfer trolley





We design.

We manufacture.

We create new products.

Exclusively distributed by



ABR109.9 201222