



# LIFESTYLE COMMUNITY CARE BED

USER MANUAL



Thank you for choosing this bed from our  
Aspire Lifestyle Community Care Bed range.

This product has been specifically designed  
to offer comfort, support and safety.

**It is important that you read this user  
manual carefully before using your new bed.**

© Aidacare Pty Ltd 2023

No part of this user manual may be copied, distributed, reproduced, scanned or stored on any electronic database, whether in whole or in part in any form or by any means.

Due care has been taken to ensure all the information contained in this user manual is correct at the time of printing. All measurements, pictures, colours and weight capacities are to be used as a guide only. We reserve the right to modify the design or appearance of any product displayed in this user manual without prior notice.

# TABLE OF CONTENTS

---

1. Introduction	4
2. Safety Precautions	5
3. Product Overview	7
4. Unpacking & Inspection	8
5. Assembly Instructions	9
6. Operation	12
7. Accessories	14
8. Transport & Storage	15
9. Troubleshooting	17
10. Cleaning	18
11. Service & Maintenance	19
12. Specifications	21
13. Technical Information	22
14. Warranty	22
15. Service Log Book	23

# 1. INTRODUCTION

---

The Aspire Lifestyle Community Care Bed is an electrically operated bed for the community or homecare environment. The bed has a fabricated steel frame with a powder coat finish and utilises plastic components of various material specifications.

## **Clinical Applications and Area of Use**

The bed is appropriate for adult patient care and should only be used under the instruction of a carer or health professional where concerns exist around patient safe use.

## **Key Features**

- Maximum safe working load (SWL) of the bed is 220kg with a maximum user weight of 180kg.
- Available in Single and King Single sizes.
- Electrically adjusted height range of 220 - 710mm.
- Total lock foot operated castor wheels.
- Four section electrically operated mattress platform with independent adjustment of backrest angle (maximum 60°) and knee section angle (maximum 30°).
- Trendelenburg / Reverse Trendelenburg angle of 10.5°
- Removable mattress retainer handles.
- Integrated bed extension at foot end extends the bed by 100mm in total.
- Removable bed end sections and transportation kit facilitates easy relocation and storage.

## 2. SAFETY PRECAUTIONS

---

It is **IMPORTANT** that this User Manual is read in its entirety prior to operating the bed. The manual is designed to ensure that users are equipped with the information required to competently and responsibly operate the bed and its accessories.

It is recommended that the User Manual be kept in an easily accessible place for quick reference. If required, Aspire product specialists can provide additional training.

All warnings and cautions within this manual should be strictly adhered to. Failure to do so could result in harm to the patient or operator.



**WARNINGS** highlighted throughout this manual identify possible hazards in procedures or conditions which if not followed correctly could result in serious injury or fatality.



**CAUTIONS** highlighted throughout this manual identify possible hazards in procedures or conditions, which if not followed correctly could result in equipment damage or failure.

### GENERAL

- Electrical equipment can be hazardous if used incorrectly.
- Residual current devices (RCD) are not supplied with the Aspire Lifestyle Community Care Beds. Please consult with your Biomedical Engineer/Advisor concerning RCD requirements.
- The clinically qualified person responsible should consider the age, size and condition of the patient before using the bed and its accessories.
- The maximum safe working load of the Aspire Lifestyle Community Care Bed is 220kg including the mass of the patient, mattress and any accessories fitted to the bed.
- The maximum user weight is 180kg.
- Suggested Maximum mattress thickness that can be used on the Aspire Lifestyle Community Care Bed is 150mm.
- Side rails must only be used with a mattress of appropriate size, which is approved for use with the bed.
- If a patient's condition could lead to possible entrapment risk the mattress support platform should be left in the flat position whilst unattended.



**ALWAYS** position the bed at its lowest height when unattended by caregivers to minimise the risk of patient injury.



**ALWAYS** use a mattress of appropriate size and type. A range of suitable pressure reducing and pressure relieving mattresses are also available from Aidacare.



**ALWAYS** make sure that the patient is safely positioned to minimise the risk of entrapment before operating the bed.



**ALWAYS** ensure that attendant and patient limbs are free from potential entrapment areas before operating any functions.



**ALWAYS** ensure that the bed is at a suitable height to avoid stooping or straining before transporting.



**ALWAYS** apply the brakes when the bed is stationary.



**ALWAYS** store the handset when not in use to avoid accidental operation of the beds functions. The handset can be stored by hooking it on to the side rail of the bed.



**ALWAYS** ensure that all drips, drains and power cables are free from possible entanglement with mechanical parts of the bed.



**DO NOT** place the handset, or power cord across the mattress surface of the bed when the bed is not connected to mains power. Always store the power cord within the power cord fixtures fitted to the bed.



**DO NOT** use electrically operated beds in operating theatres.



**DO NOT** use electrically operated beds in the presence of flammable gases.



**DO NOT** use the bed to support more than one patient. Aspire Lifestyle Community Care beds are intended for single person use and may become unstable if used incorrectly.



**DO NOT** use accessories that are not designed, or approved for use with Aspire Lifestyle Community Care beds.

# 3. PRODUCT OVERVIEW

The Aspire Lifestyle Community Care Bed range is designed specifically for the community and aged care environment. Please take the time to familiarise yourself with the key components shown below:

### FOOT END

Marked for ease of identification

### HEAD SECTION

Raises the patient's upper torso to a sitting position

### HEAD END

Marked for ease of identification

### MATTRESS PLATFORM

(mattress surface)

### LINAK ELECTRONICS

### LIFT ACTUATOR

### LIFT ACTUATOR

### EASY MOVE LOCKING CASTORS

Locking with foot lever



### HANDSET

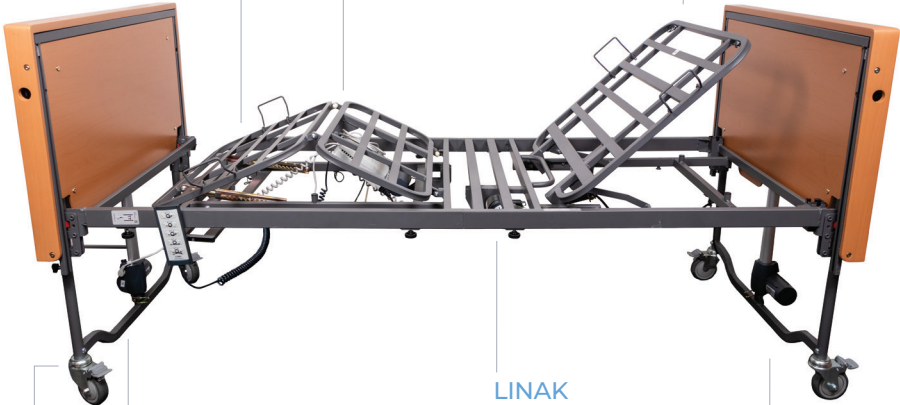

## 4. UNPACKING & INSPECTION

Aspire Lifestyle Community Care Beds come packaged on their transport bracket, ready to be transported as necessary. Remove cardboard sleeves off bed ends and central frame and check that all components are present and not missing.

(Accessories supplied separately)

**A** Head end with lift actuator

**B** Foot end with lift actuator

**C** Mattress platform

**D** Linak Electronics

**E** Removable Mattress Guides x4

**F** Handset

**G** Transport Bracket

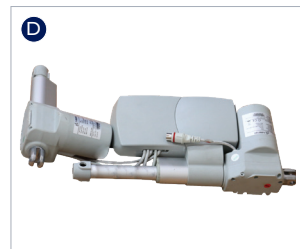



# 5. ASSEMBLY INSTRUCTIONS

## PREPARE ALL COMPONENTS FOR ASSEMBLY

**NOTE:** Beds come supplied as standard on their transport brackets. Refer to '8. Transport & Storage' for instructions on how to assemble & disassemble the bed from the transport/ storage position.

1. Find a clear space and ensure bed end castors are locked for easier assembly.
2. Ensure all components mentioned in '4. Unpacking & Inspection' are laid out ready to be installed.

**Assembly of the Lifestyle Community Care Bed is a 6 stage process. When fitting the premium shrouds and side rails, this becomes an 8 stage process.**

## 5.1 CONNECTING THE TWO MATTRESS PLATFORM SECTIONS

- i. Lay the two mattress platforms on a flat surface.
- ii. Insert connecting rods into centre of mattress platforms.
- iii. Secure in place with fastening hand wheels.
- iv. Slide the two halves gently together ensuring the connecting rods are now both concealed within the mattress platform.
- v. Fasten the 4 hand wheels (2 on each side) at the centre of the platform where the two frame halves join.
- vi. Insert footend connecting bracket to the end of the platform (foot end)
- vii. Secure in place with fastening hand bolts



## 5.2 CONNECTING THE TWO BED ENDS

- i. Align the foot end bed end with the foot end of the mattress platform (identified by 'FOOT' sticker).
- ii. Slot in the connectors on mattress platform into receiver points on bed end.
- iii. Rotate plastic bush on bed end to lock in place.
- iv. Repeat steps 1 to 3 to connect the HEAD section (identified by 'HEAD' sticker) onto the mattress platform.



## 5.3 CONNECTING ALL ACTUATORS AND HANDSET

**NOTE:** Only bed end actuators (Hi LO) need to have their cables disconnected and reconnected. All other actuators remain in place with cables connected throughout transport and general bed usage.

- i. Connect the 'hi-lo' actuator cable at the head and foot end.
- ii. The handset comes connected to the control box, uncouple the cabling and move the handset to either side of the bed for use.



## 5.4 ATTACHING MATTRESS RETAINERS

- i. Slide mattress guides into metal slots located on the side at both ends of the bed (4 x guides in total).



## 5.5 ATTACHING SELF HELP (OPTIONAL ACCESSORIES)

- i. Insert self-help pole into sleeve at head end of the bed, aligning the notch with the groove.
- ii. Assemble IV pole using the 2 bolts supplied to the main frame of the bed



## 5.6 MOUNTING 3/4 SIDE RAILS

- i. Unscrew fastening hand wheels to bring side rail locking clamp into an open neutral position.
- ii. Align side rail mounting plate with side of mattress platform ensuring that when rails swing away, they swing towards the foot end of the bed.
- iii. Tighten fastening hand wheels to lock rails into place.
- iv. Release rails into the downward position by pulling black spring button.

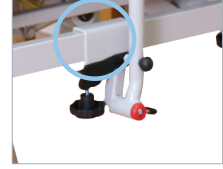

## PREMIUM BED END SHROUDS & FULL LENGTH SIDE RAILS

### 5.7 MOUNTING FULL LENGTH SIDE RAILS

1. Mount side rail sliding mechanism to each side of full length side rails.
  - i. If the bed platform is extended, please use BEA029864 (Bed side rail extension kit)
- ii. Insert side rail sliding mechanism upwards into the vertical track mounted to either side of the bed ends.
- iii. Lock side rails in raised position by pulling upwards until they click into place, release by pulling black spring button at either end of the rail.
- iv. Secure with fastening hand wheels at base of vertical mounting track.



### 5.8 MOUNTING BED END SHROUDS

- i. Place shroud end over each bed end.
- ii. Lock in place using an Allen key to fasten 4 x screws (2 on each side)



## 6. OPERATION

### ACTIVATING THE HANDSET

The handset has a locking key permanently fastened to the cord. This is designed to lock out functionality for patients with safe use concerns when unsupervised.

To lock out positions, insert the key with the function you want locked out and turn to the right to lock and left to unlock.



Power on light indicates system is active.

### 6.1 HAND CONTROL FUNCTIONS

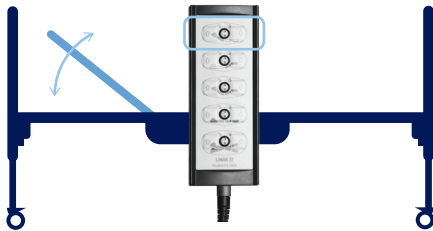

Backrest incline/decline



Knee bend incline/decline



Backrest & knee bend synchronous incline/decline

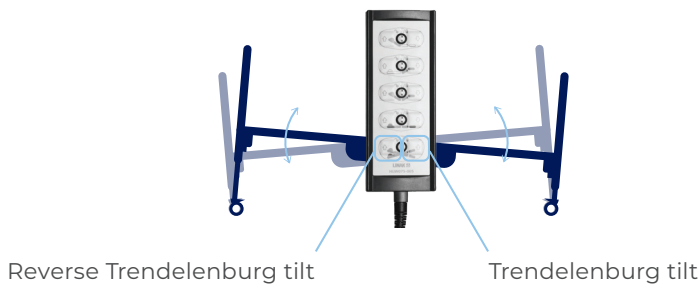
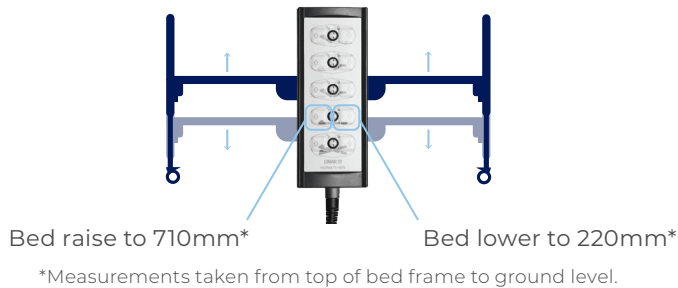

Always ensure that a health professional has assessed the patient regarding their suitability for Trendelenburg positioning.

## 6.2 CASTOR USE

- This bed has 4 total-lock castors.
- To apply the brake, use your foot to press down on the lever at each castor.
- To unlock the brake, use your foot to down on the unlocking latch at the top of the castor.

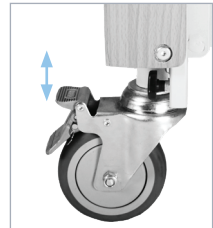

## 6.3 SELF-HELP POLE

- This should be placed on the side of the bed that the user gets in/out of bed to assist for safe egress. Ensure that the Self Help Pole is sitting securely in place with notch in groove.



## 7. ACCESSORIES

---

The following accessories are sold separately or as part of a bed package kit.



### **3/4 FOLDING SIDE RAILS**

BEA016586

Refer to page 10 for further instructions.



### **IV POLE**

BEA016592



### **FULL LENGTH SIDE RAILS**

BEA029863 – Full Length Rails

BEA029864 – Extension Piece  
(for use with bed extension)

Refer to page 11 for further instructions.



### **TRANSPORT KIT**

BEA029871

Refer to page 15 for further instructions.



### **BED END SHROUDS**

BEA029850 – Single | BEA029855 – King Single

Refer to page 11 for further instructions.

## 8. TRANSPORT & STORAGE

### TRANSPORTATION ASSEMBLY INSTRUCTIONS

The Aspire Lifestyle Community Care Bed Range is designed to be transported safely on the ground by one person. This requires the bed to be disassembled and repositioned on the Transportation Kit which is included with each bed as standard.



Assembly for transportation is a 6 step process.

#### 8.1 PREPARE TO SEPARATE ALL BED SECTIONS

- i. Lower the bed platform to its lowest height, then unplug from power.
- ii. Disconnect the 'hi-lo' actuator cable at the head and foot end.



#### 8.2 SEPARATING THE BED ENDS FROM THE PLATFORM:

- i. Unfasten locking bush x 2 at each end of the frame and unhinge platform section from bed end by pulling upwards until completely disconnected.
- ii. Apply the head and foot end brakes so the ends can lean safely up against something while you work on the bed platform section.
- iii. The bed platform will now be lying on the floor with the 2 halves still joined and the actuators underneath it.



#### 8.3 SEPARATING THE PLATFORM SECTIONS:

- i. Unfasten (but don't remove) the 4 hand wheels (2 on each side) at the centre of the platform where the 2 frame halves join.
- ii. Slide the two halves gently apart. Remove the connecting rod on each side and place it next to the bed ends.





#### 4. PREPARING TO MOUNT THE BED ENDS:

- i. Place the two Transport Brackets in a matching stance on the floor perpendicular to the bed ends.
- ii. Mount brackets between bed ends the same way that you mount the mattress platform. Align the hooks of the transport bracket with the bed end, slot in and lock in place by twisting the rotational bush (x 4) on the bed ends.

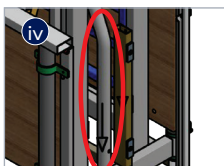
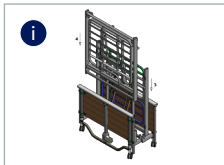

#### 5. MOUNTING THE PLATFORM SECTIONS:

- i. Position the foot end platform on its end so the remaining actuator connection is at the top and the actuator hangs down.
- ii. Hold or cable tie loose cables out of the way to avoid interference when mounting.
- iii. With the mattress platform facing outwards towards the foot end, lower the platform section onto the vertical receiver rods on the transport brackets.
- iv. Repeat the same for the head end platform.
- v. You may choose to loop or bunch the cables and handset on the inside of the two standing platform halves. There are various points to hang from without having to use ties however for extra securement use cable ties as desired.
- vi. Place the platform connector rods into the receiver mounts on each transport bracket.
- vii. Separate the self-help pole and place each half into the round receiver mounts on each transport bracket.

**NOTE: The bed is now ready for safe transportation or storage. Reverse all steps to reassemble.**



## STORAGE CONDITIONS

Aspire Lifestyle Community Care Beds should be stored in a clean, dry, well ventilated area.

The following limits apply during transport and or a storage period of up to 15 weeks duration:

Ambient Temperature: -25°C - +70°C

Relative Humidity: 10% - 75%

Air Pressure: 50kPa - 106kPa

## 9. TROUBLESHOOTING

Fault	Cause	Solution
Controller inactive and power on light is not active	Power fault	<ul style="list-style-type: none"><li>• Primary power cable connection should be checked for cable damage and correct insertion.</li><li>• All power leads to actuators should be checked for correct insertion and or damage.</li></ul>
Lift Actuator control not working	Linak Electronics Fault	<ul style="list-style-type: none"><li>• All power leads and plugs should be checked for correct insertion and not visible damage.</li><li>• Connector pins should be aligned, any unusual bends may suggest damage.</li></ul>
Handset buttons do not work?	The safety lockout function is active	<ul style="list-style-type: none"><li>• Ensure specific function is not locked out and that handset cable is securely fastened.</li></ul>

 Should problems persist contact Aspire Service on 1300 133 120.

## 10. CLEANING

---



### **WARNING**

Before cleaning always disconnect the bed from the mains power source and remove Linak electronics system from mattress platform.

**NOTE:** It is strongly recommended that protective clothing be used when cleaning.

**NOTE:** The following procedure also applies to the bed accessories, but does not include mattresses.

- Wipe the bed surfaces with a soft cloth moistened with hot water and mild detergent (or the facility's recommended cleaning solution). It is recommended that the cloth be a white material to prevent bleeding of dye colours to the bed. Take extra care in areas that can harbour dirt or dust.
- Rinse with clean water and a dry clean cloth.
- To remove potentially infectious materials such as body fluids, or when the bed has been used by someone with a known infection, clean with NaDCC (e.g. Presept, Actichlor) at 10,000 ppm of available chlorine. Rinse and dry.
- Allow the cleaned parts to dry before replacing the mattress.



### **CAUTION**

Do not use abrasive Hypocarbonate or Phenolic compounds or pads.

## 11. SERVICE & MAINTENANCE

---

To prolong the working life of the bed and for trouble free operation it is recommended that routine inspections should be performed by a person who is suitably qualified and well acquainted with the design, use and care of Lifestyle Community Care Beds.

If inspection reveals that the safety of the bed is compromised in any way, it should be **IMMEDIATELY WITHDRAWN FROM SERVICE**, tagged as such and the owner notified, until repair or replacement has occurred.

### **INSPECTION:**

A visual and functional inspection should be performed monthly and every time the bed changes user.

- Visually inspect electrical components: can you see damage to the hand control or power cord?
- Visually inspect mechanical components: can you see damage, chips or deformation to the frame, bed ends, side rails or self help pole?
- Is the hand control functioning as it should?
- Are the castors, brakes and accessories functioning as they should? Preventative Maintenance:

**NOTE:** Other than general maintenance activities all other service or repair work must be performed by qualified and trained persons or agents approved by Aidacare.

The following preventative maintenance procedures should be carried out every 12 months or as otherwise specified:

- i. Overall functional check that all hand control functions are operating the bed as expected.
- ii. Overall inspection for visible signs of wear, tear or damage to the integrity of electronics and cables.
- iii. Actuators and all moving components should not make unusual noises.
- iv. Side rail attachment and function should be assessed along with the locking integrity of castors.
- v. Electrical test & tag – where beds are in use in a commercial environment then the testing regime applied should align with the risk assessment made by the owner for safety and other compliance requirements.



**WARNING:** The bed must be disconnected from the mains power supply before starting the following maintenance activities:

## General

1. Examine all the warning signs on the bed. Examine the bed for obvious signs of damage. Check that all nuts, bolts and other fasteners are tight and are not missing.
2. Examine flexible cables and conduits for cuts, cracks, abrasions or other deterioration.
3. Check that the power supply plug is not damaged. If either the power cable or plug is
4. Damaged then both the cable and plug must be replaced as a complete assembly by an approved service agent.

## Braking System

1. Apply the brakes and push the bed forwards. If any of the four braking castors rotate the brake is not fully effective.
2. Check the castors for correct operation.
3. If any are not working correctly contact an approved service agent.

## Side Rails (if fitted)

1. The locking pin mechanism and striker plate arrangement should be checked every three months.  
Inspect the side rails for general wear and tear on fittings and pivot joints every six months.  
Check for rust, structural integrity of welds and paint finish every twelve months.
2. Raise the side rail to the upright position until the locking mechanism clicks into place.
3. Check that the rail clamps are securely fitted to the bed.

## 12. SPECIFICATIONS

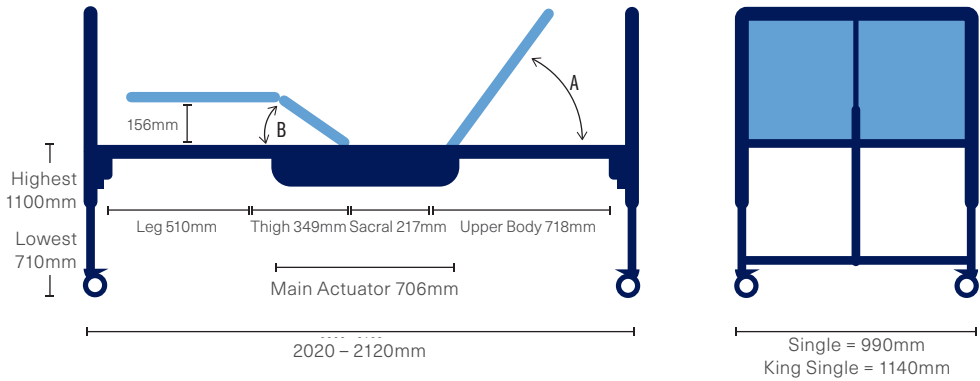

### DEGREES OF MOVEMENT

- A. Upper body profiling: 60° Max.
- B. Lower body profiling: 30° Max.
- C. Trendelenburg: 10.5° Max.
- D. Reverse Trendelenburg: 10.5° Max.

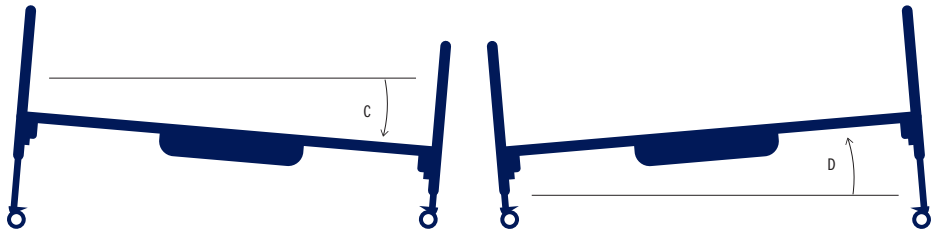

### WEIGHT CAPACITY

Safe Working Load: 220kg  
(inc. mattress & accessories)  
Max. Patient Load: 180kg

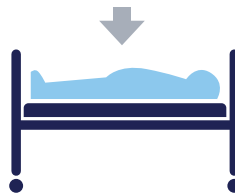

## 13. TECHNICAL INFORMATION

---

### **ELECTRICAL RATINGS:**

Voltage:	230V ~ +/- 10%V
Max current:	5A
Voltage output:	24V DC ~ max. 70V DC.
Operating Frequency:	2 min on, 18 min off Push force
Pull force:	Max 0 N to 4000N
Protection:	IP 54
Insulation:	III



User is not isolated from the ground or frame structure.

### **DESIGN FOCUS:**

IEC60601-2-52 – Anti Entrapment

For further information contact [product@aidacare.com.au](mailto:product@aidacare.com.au)

## 14. WARRANTY

---

Aspire Lifestyle Community Care Beds come with a two year warranty. Please keep the purchase invoice as proof of warranty commencement.

Aidacare is bound by Australian Consumer Law in respect to Warranty Against Defects. A copy of the Aidacare Warranty Against Defects statement is available on the Aidacare homepage at [www.aidacare.com.au](http://www.aidacare.com.au). All warranty matters should be directed to Aidacare Customer Service on 1300 133 120.

Aidacare does not warrant against excessive or incorrect use, modification or any situation that could be deemed as fair wear and tear. This is a back to base warranty and does not cover freight costs pertaining to the return of any items under warranty. Aidacare acknowledges and conforms to all ACCC guidelines around consumer rights. For further information contact Aidacare on 1300 133 120 or email [product@aidacare.com.au](mailto:product@aidacare.com.au).

Aidacare will not warrant the safety and or correct functioning of products where any original components have been changed or modified by non-Aidacare approved and trained service & maintenance staff or external providers. Furthermore, safety is not guaranteed where components have been replaced with non-original Aidacare approved parts. If any faults are detected upon receipt of this product please phone Aidacare. Any faults that are detected during normal use should be reported to Aidacare immediately to determine if warranty conditions apply and if so, the necessary repair or replacement work to be completed.

# 15. SERVICE LOG BOOK

---

<b>Year 1</b>	Date: _____
Service Type: _____	
Condition Report: _____	
Inspected by: _____	Signature: _____
Action taken: _____	Date: _____

<b>Year 2</b>	Date: _____
Service Type: _____	
Condition Report: _____	
Inspected by: _____	Signature: _____
Action taken: _____	Date: _____

<b>Year 3</b>	Date: _____
Service Type: _____	
Condition Report: _____	
Inspected by: _____	Signature: _____
Action taken: _____	Date: _____

<b>Year 4</b>	Date: _____
Service Type: _____	
Condition Report: _____	
Inspected by: _____	Signature: _____
Action taken: _____	Date: _____

<b>Year 5</b>	Date: _____
Service Type: _____	
Condition Report: _____	
Inspected by: _____	Signature: _____
Action taken: _____	Date: _____

**AIDACARE PTY LTD**

Building 3A, 1 Moorebank Avenue,  
Moorebank NSW 2170  
Australia

**1300 133 120** | [aidacare.com.au](http://aidacare.com.au)

MADE IN PRC

ASUM69.14 020524

