



aspire ALTITUDE

Vertical and Recline Chairs

USER MANUAL



ASPIRE ALTITUDE VERTICAL LIFT AND RECLINER

The symbols below are used throughout this owner's manual and on the product to identify warnings and important information. It is very important for you to read them and understand them completely.



WARNING

WARNING! Indicates a potentially hazardous condition/situation. Failure to follow designated procedures can cause either personal injury, component damage or malfunction. On the product, this icon is represented as a black symbol on a yellow triangle with a black border.



MANDATORY! These actions should be performed as specified. Failure to perform mandatory actions can cause personal injury and/or equipment damage. On the product, this icon is represented as a white symbol on a blue dot with a white border.



PROHIBITED! These actions are prohibited. These actions should not be performed at any time or in any circumstances. Performing a prohibited action can cause personal injury and/or equipment damage. On the product, this icon is represented as a black symbol with a red circle and red slash.

Please fill out the following information for quick reference:

Aspire Dealer	
Address	
Phone Number	
Purchase Date	
Serial Number	

NOTE: This owner's manual is compiled from the latest specifications and product information available at the time of publication. We reserve the right to make changes as they become necessary. Any changes to our products may cause slight variations between the illustrations and explanations in this manual and the product you have purchased. The latest/current version of this manual is available on our website.

TABLE OF CONTENTS

Label Information _____	4
1. Introduction _____	5
• Safety	
• Purchaser's Agreement	
• Information Exchange	
2. General Guidelines _____	6
• Modifications	
• Weight Limitations	
• Pinch / Crush Hazards	
• Degree of Protection / Mode of Operation	
• Storage and Operation Temp.	
• EMI/RFI	
• Shipping and Delivery	
• Motor Vehicle Transport	
3. Your ALTITUDE Chair _____	8
• Chair Component Operation	
• Electrical Components	
4. Setup _____	10
• ALTITUDE Chair Set-Up/Disassembly	
• ALTITUDE Chair Placement	
• Battery Installation	
5. Operation _____	12
• Hand Control Operation	
• Correct and Incorrect Use Guide	
6. Troubleshooting _____	16
• Frequently Asked Questions	
7. Care and Maintenance _____	17
• Fabric Care	
• Electronics Care	
8. Warranty _____	18
9. Specifications _____	19

LABEL INFORMATION

PRODUCT SAFETY SYMBOLS

The symbols below represent labels used on the product to identify warnings, mandatory actions and prohibited actions. It is very important for you to read and understand these symbols completely. Do not remove these labels from your product. Please note that not all of the symbols may be used on your ALTITUDE chair model.



Pinch/Crush Points Hazard! Do not place objects or appendages in the path of moving parts.



Do not place objects under the footrest when the ALTITUDE chair is in the fully reclined position. Make sure area is clear of obstructions, including pets and small children during operation.



Electrical Hazard



Battery Door Location



Read and follow the information in the owner's manual.



Indoor Use Only. Avoid exposure to rain, snow, ice, salt or standing water. Maintain and store in a clean and dry environment.



Maximum weight capacity



Class II Equipment



Do not connect an extension lead to the AC/DC converter or the battery charger.



Green LED indicates power to the unit is on. Not applicable to all models.



Removal of grounding prong can create electrical hazard. If necessary, properly install an approved 3-pronged adapter to an electrical outlet having 2-pronged plug access.



Degree of protection against electric shock.
TYPE B



Properly dispose of all electronic components, including the surface mounted ion battery pack, hand control, actuator motors and wiring. Contact your authorised Aspire Dealer for more information.



This product has been tested and complies to IEC 60601-1-2.



Do not place objects under the ALTITUDE chair. Make sure the area is clear of obstructions, including pets and small children during operation.

1. INTRODUCTION

SAFETY

CONGRATULATIONS on purchasing your Aspire ALTITUDE chair. The product you have purchased combines state-of-the-art components with **safety**, comfort and styling in mind. We are confident the design features will provide you with the conveniences you expect during your daily activities. Understanding how to **safely** operate and care for this product should bring you years of trouble-free operation and service.

Read and follow all instructions, warnings and notes in this manual and all other accompanying literature before attempting to operate this product for the first time. In addition, your **safety** depends upon you, as well as your dealer, carer or healthcare professional in using good judgement.

If there is any information in this manual which you do not understand, or if you require additional assistance for setup or operation, please contact your authorised Aspire Dealer. **Failure to follow the instructions, warnings and notes in this manual and those located on your Aspire product can result in personal injury or product damage and will void the Aspire product warranty.**

PURCHASER'S AGREEMENT

By accepting delivery of this product, you promise that you will not change, alter or modify this product or remove or render inoperable or unsafe any guards, shields or other safety features of this product; fail, refuse or neglect to install any retrofit kits from time to time provided by Aspire to enhance or preserve the safe use of this product.

INFORMATION EXCHANGE

We want to hear your questions, comments and suggestions about this manual. We would also like to hear about the safety and reliability of your new ALTITUDE chair and about the service you received from your authorised Aspire Dealer. Please notify us of any change of address, so we can keep you apprised of important information about safety, new products and new options that can increase your ability to use and enjoy your Aspire ALTITUDE.

Please feel free to contact us at the address below:

Australia:

Aidacare Head Office
Building 3A, 1 Moorebank Avenue,
Moorebank NSW Australia 2170

NOTE: If you ever lose or misplace your product registration card or your copy of this manual, contact us and we will be glad to send you a new one immediately.

2. GENERAL GUIDELINES

Your ALTITUDE chair is a state-of-the-art life-enhancement device designed to increase mobility. Please be aware that the final selection and purchasing decision regarding the type of vertical lift chair to be used is the responsibility of you, the user, if capable of making such a decision, and/or your healthcare professional (i.e., medical doctor, allied health professional, therapist, etc.).



MANDATORY! Read and follow the information provided in this owner's manual before attempting to operate your ALTITUDE chair for the first time.

There are certain situations, including some medical conditions, where you will need to practice operating the ALTITUDE chair in the presence of a trained attendant. A trained attendant can be defined as a family member or healthcare professional specially trained in assisting you with performing various daily living activities while safely operating a ALTITUDE chair.

Below are some precautions, tips and other safety considerations that will help you become accustomed to operating the ALTITUDE chair in a safe manner.

MODIFICATIONS

Aspire chairs are designed and engineered to provide maximum comfort and utility. However, to prevent personal injury and/or damage to your ALTITUDE chair, you should not modify, add, remove or disable any feature, part or function of your ALTITUDE chair. Unauthorised modifications may also void your product's warranty.

NOTE: Use Aspire approved parts only for all repairs and replacements.

WEIGHT LIMITATIONS

Your ALTITUDE chair is rated for a maximum weight capacity. Refer to "Appendix A" for more information.



MANDATORY! Stay within the specified weight capacity of your ALTITUDE chair. Failure to do so may result in injuries and/or product damage, Aidacare will not be held responsible for any such issues/failures.

PINCH/CRUSH HAZARDS

The scissor and lift mechanisms are labelled as pinch/crush point hazards on your ALTITUDE chair. Keep clear of these areas and make sure the path of motion is unobstructed. See figure 3.1 for pinch/crush point locations.



WARNING! Do not place objects or appendages in the path of moving parts.

DEGREE OF PROTECTION/MODE OF OPERATION

- Class II equipment/Type B protection against electric shock
- Degree of protection against the ingress of solid/liquids—IPX0
- Mode of operation—Maximum Duty Cycle: 2 min. ON/18 min. OFF

STORAGE AND OPERATION TEMPERATURES

- Transportation or storage: -75°C/-104°F to 70°C/158°F
- Operation: 10°C/50°F to 40°C/104°F

ELECTROMAGNETIC AND RADIO FREQUENCY INTERFERENCE (EMI/RFI)



WARNING

WARNING! Laboratory tests have shown that electromagnetic and radio frequency waves can have an adverse effect on the performance of electrically-powered devices, such as ALTITUDE chairs.

Electromagnetic and Radio Frequency Interference can come from sources such as cellular phones, mobile two-way radios (such as walkie-talkies), radio stations, TV stations, amateur radio (HAM) transmitters, wireless computer links, Wifi, microwave signals, paging transmitters and medium-range mobile transceivers used by emergency vehicles. In some cases, these waves can cause unintended movement or damage to the control system of electrically-powered devices. The ALTITUDE chair user can help prevent electromagnetic interference by maintaining a minimum distance between portable and mobile RF communications equipment. It is recommended that at least 3 metres (9 feet) of distance be maintained between the ALTITUDE chair and any handheld equipment emitting 10 W or more of output power. Refer to the manufacturer's literature for the handheld device to determine the maximum output power of that device.

Every electrically-powered device has an immunity (or resistance) to EMI. The higher the immunity level, the greater the protection against EMI. Per EMC standards, this product has passed immunity testing and is rated as a Group 1, Class B product, meaning the ALTITUDE chair uses RF energy only for its internal function. Therefore, its RF emissions are very low and are not likely to cause any interference in nearby electronic equipment making the ALTITUDE chair suitable for use in all establishments, including domestic establishments and hospitals.



WARNING! Be aware that mobile phones, two-way radios, laptops and other types of radio transmitters may cause unintended movement of your electrically-powered device due to EMI. Exercise caution when using any of these items while operating your ALTITUDE chair.



WARNING

WARNING! The addition of accessories or components to the ALTITUDE chair can increase the susceptibility of the chair to EMI. Do not modify your ALTITUDE chair in any way not authorised by Aidacare.

WARNING! Your ALTITUDE chair itself can disturb the performance of other electrical devices located nearby, such as alarm systems.

NOTE: If unintended motion occurs, discontinue use of the ALTITUDE chair. Contact Aidacare to report the incident

SHIPPING AND DELIVERY

Before using your ALTITUDE chair, make sure your delivery is complete as some components may be packaged individually. If you do not receive a complete delivery, please contact your authorised Aspire Dealer immediately. Where damage has occurred during transport, either to the packaging or content, please contact the delivery company responsible.

MOTOR VEHICLE TRANSPORT

If you will be transporting your ALTITUDE chair in a motor vehicle, individual components (power plug, etc.) should be secured. The ALTITUDE chair itself must also be secured (a possible hazard during vehicle braking).

3. YOUR ALTITUDE CHAIR

BODY COMPONENTS

This section describes the features of your ALTITUDE chair. Carefully review the function and location of each item described, and note that the illustrations and option locations shown in this manual may not reflect the type of ALTITUDE chair that you own.

Figure 3.1 ALTITUDE Chair Main Components

Lift Mechanism: Responds to the hand control commands to position the chair in the sit, recline and stand positions.

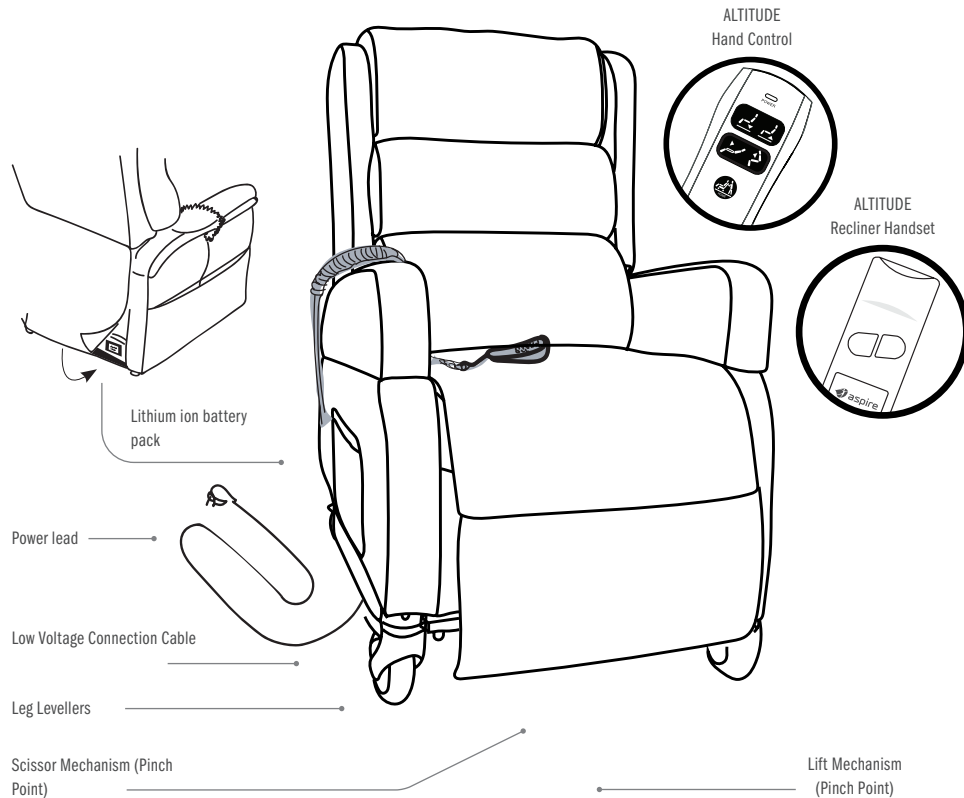

Figure 3.2 Tente castor operation

Tente castors: Your ALTITUDE chair is equipped with four castors (including two rear lock). It is recommended that castors are locked when the chair is stationary. *Remember* to unlock castors before transporting the user, as this may damage the chair, castors and/or floor.

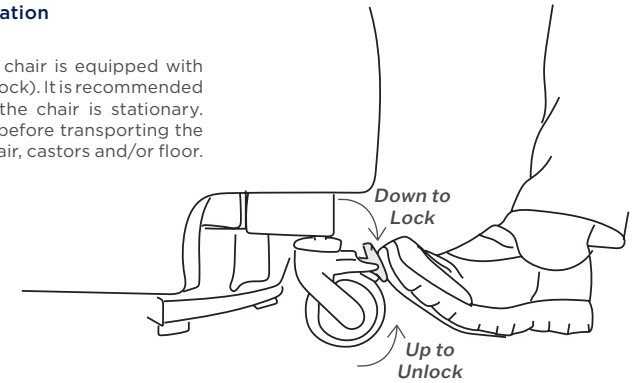

Figure 3.3 Scissor Mechanism

Scissor Mechanisms: Extend or retract the chair through the various stages of lift and recline.



WARNING! Pinch/Crush Points Hazard! Be aware that the lift mechanism and scissor mechanisms are a pinch point on the ALTITUDE chair. Keep the following items and similar objects clear of these points when operating the ALTITUDE chair:

- Appendages
- Small children
- Pets
- Wires
- Oxygen tubes
- Loose items, including but not limited to clothing and blankets
- Electrical power leads

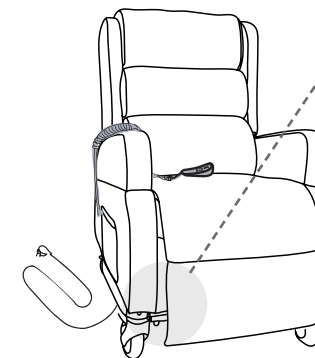
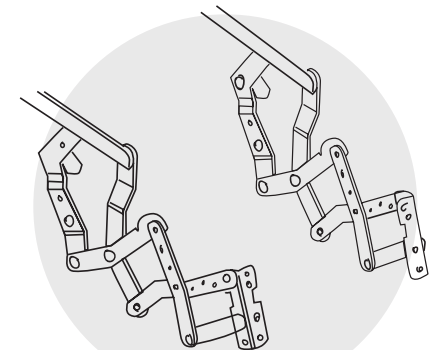

Scissor Mechanism (Pinch Point)

4. SETUP OF YOUR ALTITUDE CHAIR

Your ALTITUDE chair may require some assembly before initial use, this includes mounting the handle bar to the backrest.

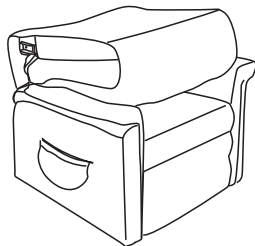

HANDLE BAR SET-UP

1. To secure the handle to the backrest it is recommended that all screws are tightened gradually and in thirds [Fig 4.1].
2. Using an **6mm Allen-key** or **electric drill with a 6mm Hex-bit** [Fig 4.2] place each screw into the bezel and begin to gradually tighten [four in total], fastening the handle to the chair backrest. We suggest following the sequence of A, B, C, D, then back to A, B, C, D, and finally A, B, C and D.

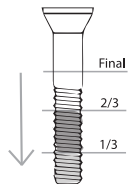

(Fig. 4.1)

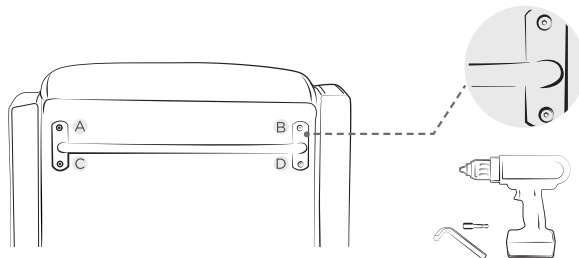

(Fig. 4.2) ALTITUDE chair with handle bar

ALTITUDE CHAIR BACKREST SET-UP

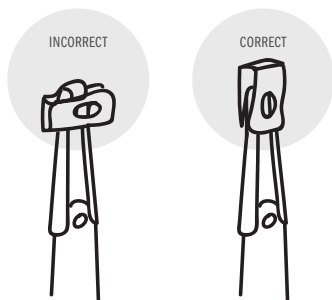

4.3.1 Remove the packaging from the back portion of the chair and check that the locking clip is in the vertical position. Reposition if necessary.

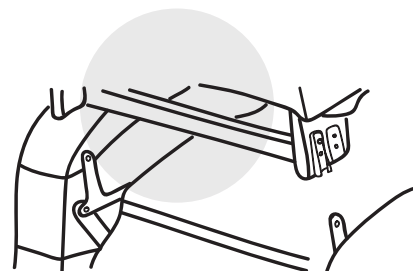

4.3.2 Slide the left and right sleeves of the backrest onto the connections on the arms and seat of the chair.

NOTE: You may need to slide on one side of the backrest at a time. If this is the case, level the chair back before pressing down to lock into position.



4.3.3 Push firmly on the top of the backrest to lock into position. Listen for a click on each side to ensure the backrest is locked in properly.

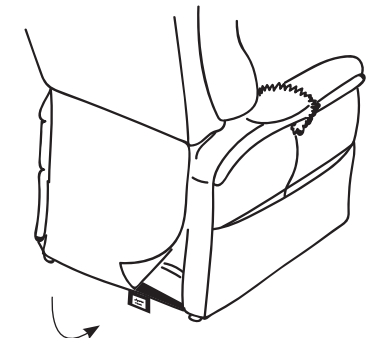

4.3.4 Attach the backrest to the hook and loop flaps on the bottom of the chair base.

NOTE: Pull up on the backrest to ensure that it is locked in place. If the back can be pulled off, then repeat steps 4.3.1 through 4.3.3

ALTITUDE CHAIR PLACEMENT & USE

Your ALTITUDE chair should be placed near a standard electrical outlet on dry, level ground where there is ample room to allow for proper operation. It is recommended that you have the assistance of an attendant when positioning the ALTITUDE chair to avoid the possibility of injury when lifting.

Follow these steps to position the ALTITUDE chair in a safe manner:

1. The back of the ALTITUDE chair should be positioned with sufficient clearance to avoid any obstructions, particularly behind the chair after reclining.
2. It is recommended that all castors are locked when the chair is stationary, and unlocked when transporting the user (Fig. 3.2).
3. Position the low voltage connection cable, away from any potential pinching points.
4. Plug the power lead directly into the electrical outlet. Do not use an extension lead!

Mobile and Agile usage:

The ALTITUDE Chair is equipped with a lithium ion battery pack to assist with mobile and agile usage. When transporting the user from one room to the next ensure that it is fully charged [see Recharging your chair] and power lead is unclipped and disconnected from the chair. To ensure that the power lead is not misplaced we recommend storing it in one of the side pockets.

Recharging your chair:

The lithium ion battery pack recharges when it is plugged into a safe electrical outlet. We recommend recharging your ALTITUDE chair when it is not in agile use and/or as frequently it is used.

NOTE: If you discover a problem at any point during the set-up and positioning of your ALTITUDE chair, stop and contact your authorised Aspire Dealer immediately. To avoid personal injury and/or product damage, do not plug the unit into the electrical outlet until the problem is corrected and do not attempt to fix electrical problems by yourself.

5. OPERATION

SAFE OPERATING PRECAUTIONS

There are certain precautions that should be taken during the operation of your ALTITUDE chair. Read and follow these precautions carefully in order to ensure safe ALTITUDE chair operation and to prevent injury and/or product damage.

- Plug the power lead directly into the electrical outlet. **Do not use an extension lead!**
- Periodically check the hand control and all power leads for visible damage.
- Keep the hand control away from all heated surfaces.
- Ensure the hand control is out of the way before sitting in the chair.
- Keep children and pets away from all moving parts while operating the ALTITUDE chair.
- Do not allow children to play on or operate the ALTITUDE chair. Only the intended user should operate the ALTITUDE chair.
- Avoid pinch points, such as the lift and scissor mechanisms. Keep hands and feet clear of these areas
- Always leave the ALTITUDE chair in an upright and closed position when not in use.
- Do not sit or stand on the footrest.
- Do not “drop” into the ALTITUDE chair when sitting if it is in a partially raised position, this will damage the seating and void warranty.



PROHIBITED! Do not place objects under the ALTITUDE chair. Make sure area is clear of obstructions, including pets and small children during operation.

WARNING! To reduce the risk of electrical shock, fire, falls and/or being pinched. Follow all instructions and precautions provided.

ELECTRICAL COMPONENTS

Your Aspire ALTITUDE chair is equipped with a low voltage DC motor system that reduces the standard household alternating current of 90V AC - 264V AC to direct current (24/39V DC). The electrical components include the Lithium Ion battery, cables, actuators & hand control. Keep these areas free from moisture at all times.



WARNING

WARNING! Keep all electrical components free from moisture at all times to prevent shock and/or electrical hazard.

Hand Control: Contains the controls needed to operate the various functions of the ALTITUDE chair. Refer to V. “5. Operation - Hand Control Operation” for more information including usability instructions. The hand control may be equipped with a quick-release connector, which enables the user to detach the hand control from the ALTITUDE chair, disabling all functions of the hand control.

HAND CONTROL OPERATION

How to use your ALTITUDE handset:



HAND CONTROL FOR ALTITUDE RECLINER

This handset has only two functions:
1. Recline
2. Retract

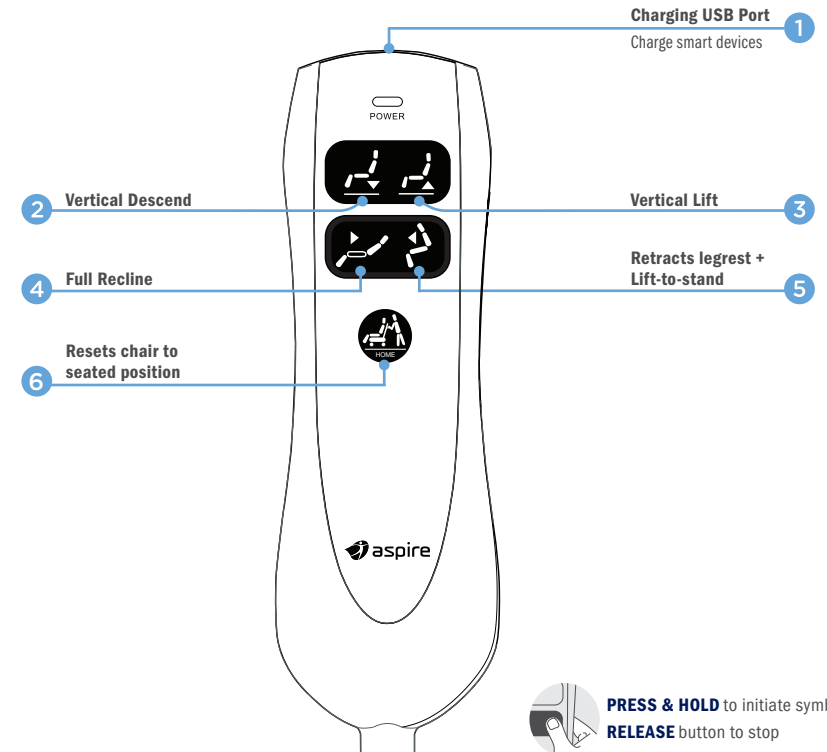

PRESS & HOLD to initiate symbol
RELEASE button to stop

NOTE: The hand control on your ALTITUDE chair is equipped with an LED that indicates power to the hand control. If the LED is present and not lit when the hand control is in use, contact your authorised Aspire Dealer.

The ALTITUDE chairs hand control determines the movement of the backrest, chair base and footrest. For specific instructions of how to use the hand control see *operating instructions above*.



WARNING

WARNING! Do not lean on or apply downward force to the backrest when the ALTITUDE chair is in the fully reclined position. Doing so could cause the ALTITUDE chair to tip, resulting in personal injury and/or product damage.

WARNING! Do not use the footrest as a seat, or for purposes outside its intended use. Doing so could cause instability in the ALTITUDE chair and place undue stress on ALTITUDE chair components, resulting in personal injury and/or product damage.

WARNING! Be sure to lock or disconnect the hand control when the ALTITUDE chair is not in use.

CORRECT AND INCORRECT USE GUIDE

DO'S AND DO NOT'S

DO'S

SITTING

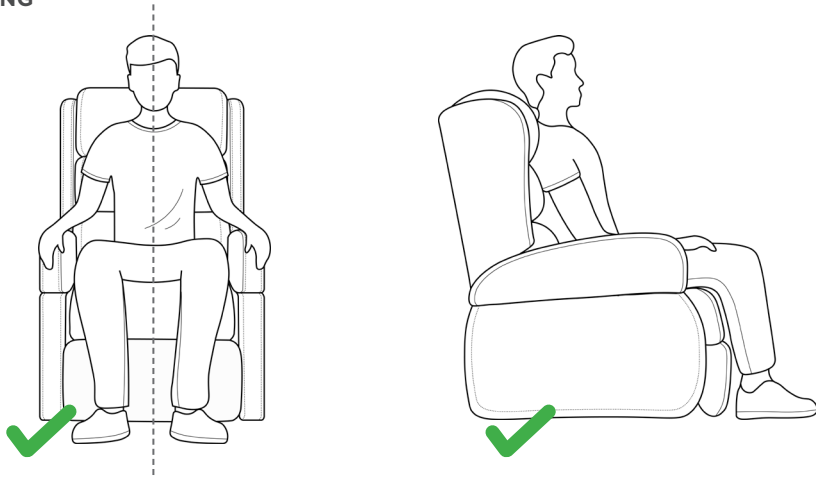

DO sit upright and centrally aligned in the chair.

LAYING

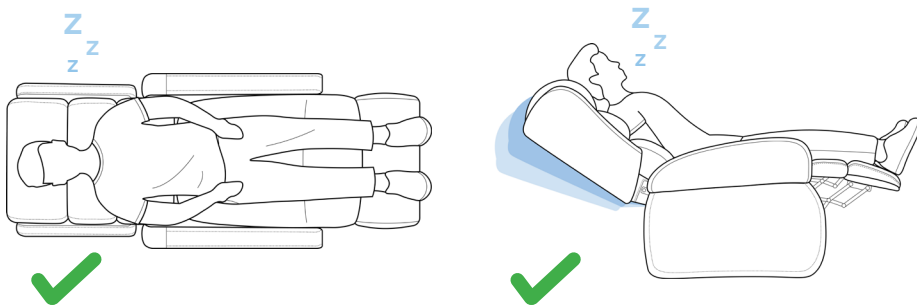

DO lie centrally and flat on the users back.



Chairs shown are for illustrative purposes only and may not be reflective of the specific chair model purchased.

DO NOT'S



Misuse may injure the user, cause pressure and/or skin tear related issues, as well as damage the product.

SITTING



DO NOT sit skewed to one side of the chair.

DO NOT sit on the armrest.

DO NOT distribute excess weight on the backrest.

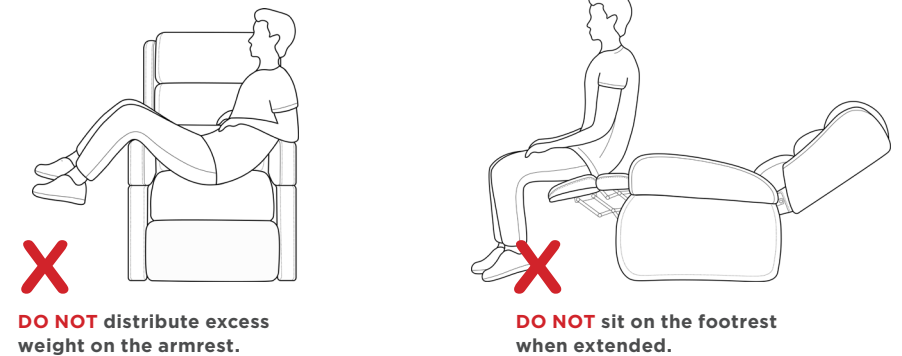

DO NOT distribute excess weight on the armrest.

DO NOT sit on the footrest when extended.

LAYING

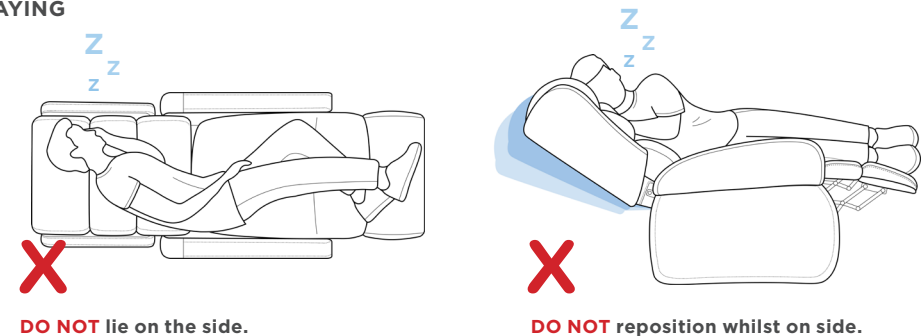

DO NOT lie on the side.

DO NOT reposition whilst on side.

6. TROUBLESHOOTING

Your Aspire ALTITUDE chair is a state-of-the-art product designed to enhance user mobility. Your ALTITUDE chair should bring you years of trouble-free service, however, it may require occasional troubleshooting. The following troubleshooting tips and FAQs should summarise what you need to know about your ALTITUDE chair. If at any time you do not feel comfortable performing the troubleshooting steps listed in this manual, contact your authorised Aspire Dealer for service. Please have the serial number and nature of the problem when calling.

FREQUENTLY ASKED QUESTIONS

What if my ALTITUDE chair does not operate at all?

- Ensure the power cord is connected and secured [via the fastening clip] to the in-built lithium ion battery pack [located at the rear of the chair underneath the fabric flap, mounted into the frame].
- Check that the battery is charged before initial and/or mobile and agile usage.
- Ensure the low voltage connection cable is plugged into the power outlet.
- Ensure that all cables are connected and secured properly.
- Check all cables for signs of damage [cuts, flattened areas].

What if my ALTITUDE chair operates in one direction only?

- Check the up and down buttons or toggle switch on the hand control to make sure they do not stick. If the buttons or switch are sticking in either position, the hand control may need to be replaced.
- Contact your authorised Aspire Dealer for further assistance.

What if my ALTITUDE chair stops during a lifting cycle?

- Ensure that your ALTITUDE chair is charged and/or plugged into an electrical power outlet. If your chair has run out of charge, safely source the nearest power outlet; securing the power cord to the battery pack via the fastening clip.

What if my ALTITUDE chair is rocking from corner to corner after I position the chair?

- The floor may be uneven or the carpet may be affecting chair position. Reposition the chair to ensure the castors and floor are levelled.

Where do I find the serial number on my ALTITUDE chair?

- You can find the serial number located at the rear of the chair underneath the fabric flap. It will be noted on the compliance sticker on the centre beam, labelled "Serial Number".

Who do I call for service?

- Contact your authorised Aspire Dealer for service.

7. CARE AND MAINTENANCE

Your Aspire ALTITUDE chair will require routine maintenance checks. You can perform some of these checks, but others may require assistance from an authorised Aspire Dealer. By following the maintenance checks in this section as scheduled, you can help ensure your ALTITUDE chair gives you years of trouble-free operation. If you have any questions regarding your ALTITUDE chair's care, contact your authorised Aspire Dealer.

FABRIC CARE

- Inspect the fabric on a regular basis for any pulls, tears or gaps
- Spot clean the multi-stretch fabric and vinyl by blotting the stain with a clean, slightly damp cloth.



WARNING! Fabric or vinyl should not be allowed to come in direct contact with any type of heat source (e.g., a space heater or cigarette). Personal injury or fire damage may occur.

WARNING! It is strongly recommended that you do not smoke cigarettes while seated in or using your ALTITUDE chair, although the ALTITUDE chair has passed the necessary testing requirements for cigarette smoking. You must adhere to the following safety guidelines if you decide to smoke cigarettes while seated in or using your ALTITUDE chair.

- Do not leave lit cigarettes unattended.
- Keep ashtrays a safe distance from the ALTITUDE chair.
- Always make sure cigarettes are completely extinguished before disposal.

NOTE: Do not use solvent-type cleaners to spot clean. Do not saturate the fabric.

Prevent damage to the fabric/vinyl; do not expose the ALTITUDE chair to direct sunlight.

ELECTRONICS CARE

- Inspect all wiring harnesses to make sure they are not damaged or frayed.
- If damage is present, unplug the ALTITUDE chair and contact your authorised Aspire Dealer for service
- Keep all electronics free from moisture and temperature extremes.
- **Aspire ALTITUDE chairs are intended for indoor use only!**



WARNING! Even though the ALTITUDE chair has passed the necessary testing requirements for ingress of liquids, you should keep electrical connections away from sources of dampness, including direct exposure to water or bodily fluids and incontinence. Check electrical components frequently for signs of corrosion and replace as necessary.

WARNING! Plastic bags are a suffocation hazard. Dispose of plastic bags properly and do not allow children to play with them.

8. WARRANTY

TWO-YEAR LIMITED WARRANTY

For two (2) years from the date of purchase, Aidacare will repair or replace at our option to the original purchaser any of the following parts found upon examination by an authorised representative of Aidacare to be defective in material and/or workmanship:

- Motor
- Mechanism

IMPORTANT INFORMATION!

Improper and/or incorrect usage of the product will void product warranty. Please familiarise and refer to the “Correct and Incorrect Use Guide” located in the “Operation” section of the user manual for more details.

NOTE: Aidacare reserves the right to replace only the part of the lift mechanism that may be defective. Aidacare provides parts only under warranty. Your Aspire Dealer is responsible for labour and service. Please contact your Aspire Dealer for information about these services and for any applicable charges.

TWO-YEAR TEXTILE WARRANTY

Aidacare guarantees to replace any fabric that is found to be faulty as a result of manufacturing defect and which has been used in accordance with our manufacturer performance ratings and care instructions. An evaluation of textile related issues must be conducted before confirmation of warranty coverage can be verified.

ONE-YEAR LITHIUM ION BATTERY PACK & HAND CONTROL WARRANTY

Aidacare guarantees to replace any lithium ion battery pack or hand control that is found to be faulty as a result of manufacturing defect and which has been used in accordance with our manufacturer performance ratings and care instructions.

CONSUMER WARRANTY AGAINST DEFECTS:

Aidacare is bound by Australian Consumer Law in respect to Warranty Against Defects. A copy of the Aidacare Warranty Against Defects statement is available on the Aidacare home page at www.aidacare.com.au. All warranty matters should be directed to Aidacare Customer Service on 1300 133 120.

Aidacare does not warrant against excessive or incorrect use, modification or any situation that could not be deemed as fair wear and tear. This is a back to base warranty and does not cover freight costs pertaining to the return of any items under warranty. Aidacare acknowledges and conforms to all ACCC guidelines around consumer rights. For further information contact Aidacare on; 1300 133 120 or email product@aidacare.com.au.

Aidacare will not warrant the safety and or correct functioning of products where any original components have been changed or modified by non-Aidacare approved and trained service & maintenance staff or external providers. Furthermore, safety is not guaranteed where components have been replaced with non-original Aidacare approved parts. If any faults are detected upon receipt of this product please phone Aidacare. Any faults that are detected during normal use should be reported to Aidacare immediately to determine if warranty conditions apply and if so, the necessary repair or replacement work to be completed.

Spare parts list is available upon request.

9. SPECIFICATIONS

SEAT HEIGHT (mm)	SEAT DEPTH (mm)	SEAT WIDTH (mm)	SEAT TO TOP OF BACK (mm)	OVERALL HEIGHT (mm)	OVERALL DEPTH (mm)	OVERALL WIDTH (mm)	OVERALL RECLINE (mm)	S.W.L (kg)
------------------	-----------------	-----------------	--------------------------	---------------------	--------------------	--------------------	----------------------	------------

CHP227700 ALTITUDE Chair	480 - 640	550	510 - 540	730	1180 - 1340	910	730	1780	150kg
CHP227705 ALTITUDE Chair Single Motor Recliner	500	500	550	780	1180	1000	750	1780	150kg

NOTES

AIDACARE PTY LTD

Building 3A, 1 Moorebank Avenue,
Moorebank NSW Australia 2170

1300 133 120 | www.aidacare.com.au

MADE IN PRC